



Residual current operated circuit breaker

**S3-EL Series Smart MCCB Instruction Manual**  
**V1.3**

Manufacturer: SHANGHAI MATIS ELECTRIC CO., LTD

©Matis Co., Ltd.

November 2022



# Index

<b>Foreword</b> .....	<b>1</b>
<b>1 Overview</b> .....	<b>1</b>
1.1 Application .....	1
1.2 Function and Features .....	1
1.3 Model and Meaning .....	3
1.4 Appearance and Dimensions .....	4
1.5 Working Environment .....	6
<b>2 Communication</b> .....	<b>8</b>
2.1 Methods .....	8
2.2 Communication Function Description .....	11
2.3 SIM Card Pluggable Instructions .....	13
2.4 External Pluggable Terminals .....	14
2.5 CAN Bus Interface .....	15
<b>3 Technical Parameters</b> .....	<b>15</b>
<b>4 Protection Characteristics</b> .....	<b>21</b>
4.1 Overload Long Delay Protection .....	21
4.2 Short Circuit Short Delay Protection .....	22
4.3 Instantaneous protection .....	22
4.4 Residual Current Protection .....	23
4.5 Overvoltage Protection .....	24
4.6 Undervoltage Protection .....	24
4.7 Phase Loss Protection .....	25
4.8 Linkage Protection .....	25
4.9 Island Protection .....	25
<b>5 Tripping Curve</b> .....	<b>26</b>
<b>6 Installation and Operation</b> .....	<b>26</b>
6.1 Installation Precautions .....	26
6.2 Operation .....	27
<b>7 Operation Instructions</b> .....	<b>29</b>
7.1 Main Menu .....	29
7.2 Parameter settings .....	30
7.3 System Settings .....	48
7.4 Query Records .....	59
7.5 Operation and Maintenance .....	63
7.6 Energy Analysis .....	65
7.7 About .....	67
<b>8 Photovoltaic Application Configuration</b> .....	<b>67</b>
8.1 Recommended Configuration for Photovoltaic .....	67
8.2 Precautions for Photovoltaic Protection Function .....	68



<b>9 Installation and Wiring</b> .....	<b>69</b>
<b>10 The Cross-sectional Area of the Connecting Wire and the Rated Current of the Trip Unit</b> .....	<b>70</b>
10.1 The Rated Current is not More Than 400A.....	70
10.2 The Rated Current is More Than 400A.....	70
<b>11 Transportation and Storage</b> .....	<b>71</b>
11.1 Transportation.....	71
11.2 Storage.....	71
<b>12 Maintenance Precautions</b> .....	<b>71</b>
<b>13 Statement</b> .....	<b>72</b>



## Foreword

Thank you for using our product, I hope you can understand the operation method of the product clearly and conveniently through this product manual. Please read it carefully before use for correct installation and routine maintenance.

## 1 Overview

### 1.1 Application

The S3-EL residual current operated circuit breaker has a rated insulation voltage of 1000V and is suitable for use in distribution networks with AC 50Hz, rated voltage 400V and rated current 50A~630A. The product can not only provide indirect contact protection, effectively prevent fire hazards caused by device insulation damage and ground fault current generation, but also can be used to distribute electric energy to protect lines and power device from overload, undervoltage, short circuit, single-phase grounding and other faults. In addition, the built-in high-precision measurement device realizes high-precision and reliable power measurement and power quality data detection.

#### **Standards:**

- GB/T 14048.1-2012 “Low Voltage Switchgear and Control Device Part 1: General Provisions”
- GB/T 14048.2-2008 “Low Voltage Switchgear and Control Device Part 1: Circuit Breakers”
- GB/T 17701-2008 “Circuit Breaker for Device”
- GB/Z22202-2008 “Reliability Test Method for Residual Current Operated Circuit Breakers for Household and Similar Purposes”
- JB/T 10494-2005 “Reliability Test Method for Residual Current Operated Circuit Breakers for Household and Similar Purposes”
- JB/T 8979-2006 “Residual current operated circuit breakers with or without overload protection”

### 1.2 Function and Features

- 1) High-performance 32-bit ARM microprocessor is used for real-time signal acquisition and processing.
- 2) Double CPU double protection electronic tripping, high breaking capacity design. Long-delay, short-delay

and instantaneous three-stage protection can reliably perform overcurrent and short-circuit protection functions when the line voltage is abnormal. Long-delay supports current inverse time limit operation to ensure the reliability of line protection.

- 3) Supports short circuit, overvoltage, overcurrent, overload, overtemperature, phase loss, unbalance, neutral loss (only three-phase unbalanced loads support), and residual current protection. Various protection functions and parameters can be set and modified online.
- 4) Support fault automatic reclosing function, close function, close delay and close times can be configured.
- 5) Built-in high-precision measurement dedicated chip, supports high-precision current, voltage, active power, reactive power, apparent power measurement, and the energy measurement accuracy can reach 0.5. It can display various electrical parameters, alarm information and operating status in real time.
- 6) Real-time monitoring of the residual current of the line, and the fastest time of holding action can reach 0.05 seconds. The residual current gear can be adjusted online, and supports adaptive tracking adjustment of the residual current gear.
- 7) Support power quality analysis function, which can monitor grid frequency, harmonics, unbalance, and support real-time display of current and voltage waveforms of each phase.
- 8) Support the function of accumulating electricity in sharp, peak, shoulder and off-peak, and supports two-way energy statistics.
- 9) Equipped with the temperature detection function of the upper and lower terminals, the accuracy is  $\pm 1^{\circ}\text{C}$ , and the line heating protection can be performed.
- 10) Support infrared and RS485 communication functions, and can also plug in standard communication modules to support 4G, HPLC, WIFI communication, support cloud platform, and realize remote signaling, telemetry, remote control, and remote adjustment.
- 11) Perfect log system, parameter modification, fault protection, opening and closing control can be recorded and queried.
- 12) LCD menu design, multi-language support, ON/OFF and status indicators, friendly man-machine interface, easy to operate.

### 1.3 Model and Meaning

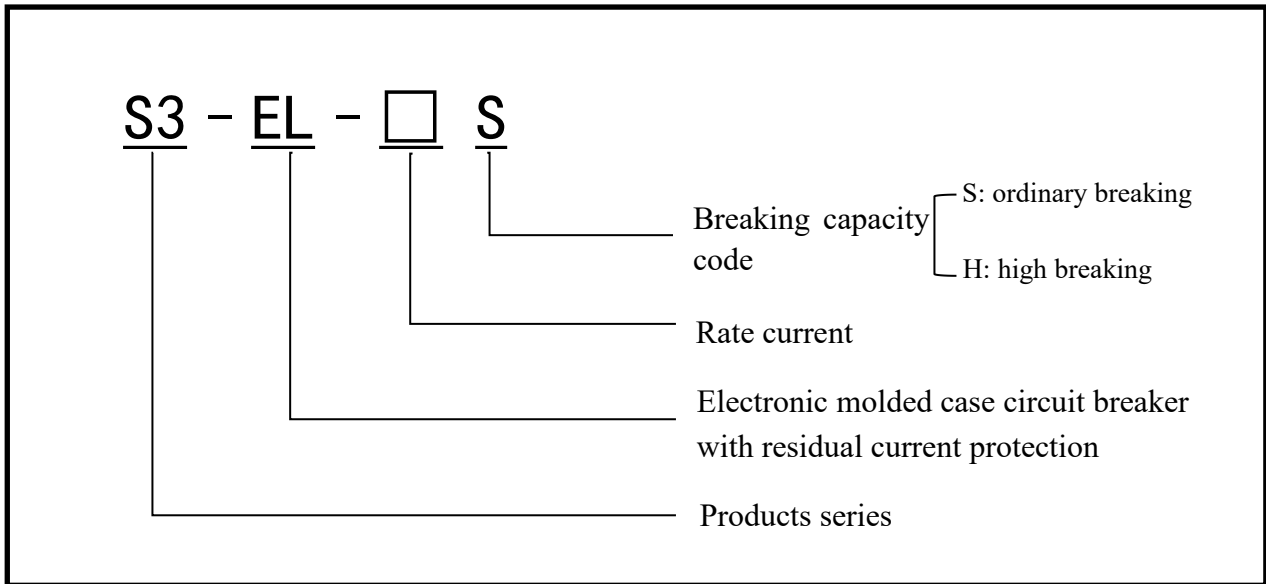

## 1.4 Appearance and Dimensions

### 1.4.1 S3-EL125S Appearance and Dimensions

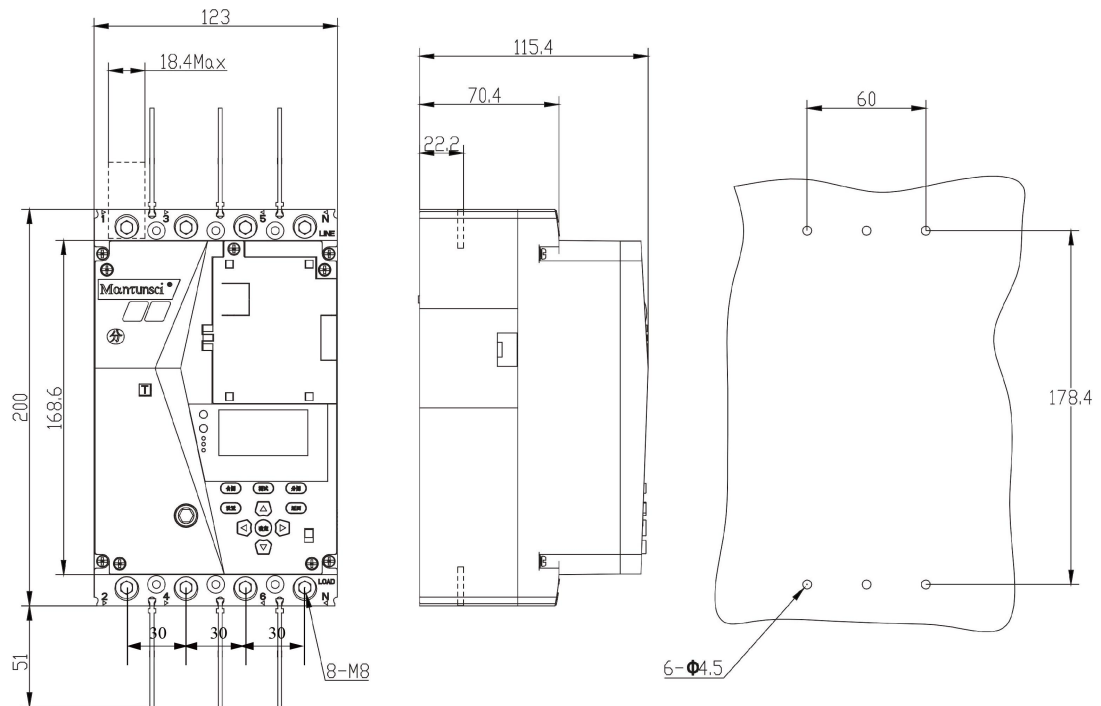

Note: Tolerance class according to GB/T 1804-c

Diagram 1-1 S3-EL125S

## 1.4.2 Appearance and Dimensions

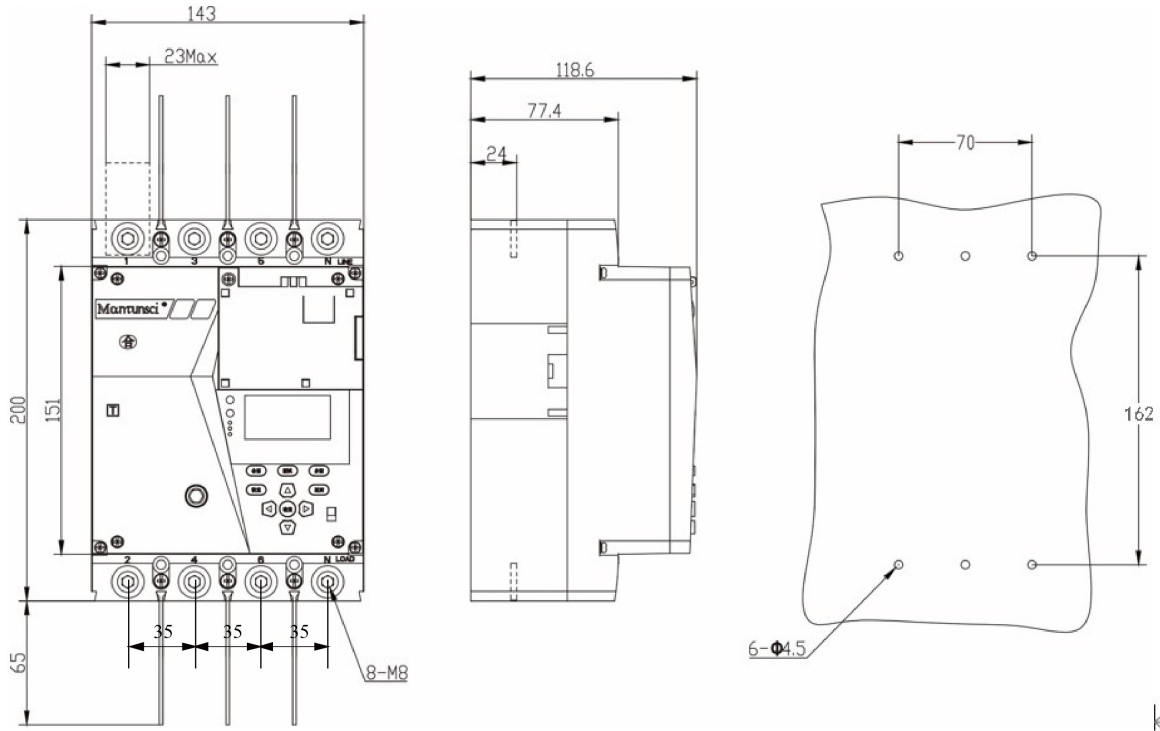

Note: Tolerance class according to GB/T 1804-c

Diagram 1-2 S3-EL250S

### 1.4.3 S3-EL400S&630S Appearance and Dimensions

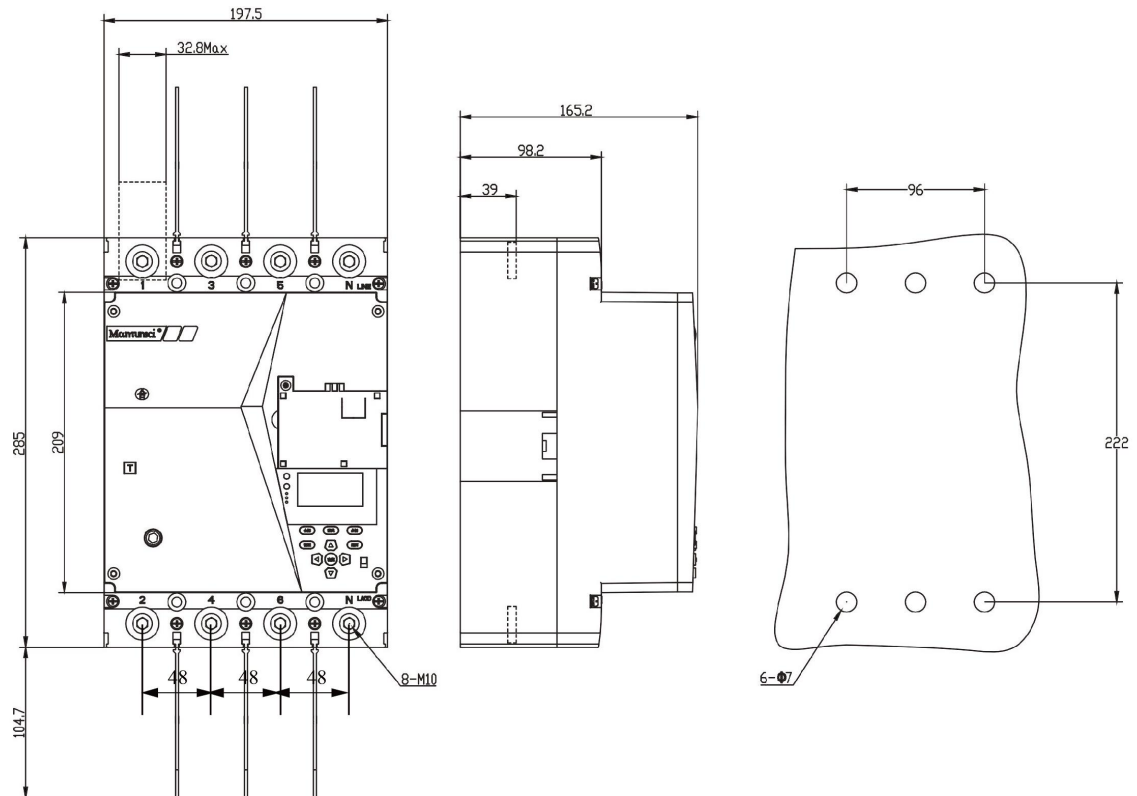

**Note:** Tolerance class according to GB/T 1804-c

*Diagram 1-3 S3-EL400S & S3-EL630S*

## 1.5 Working Environment

- The installation site should be free of conductive dust, corrosive gas, inflammable and explosive gas, and free from rain and snow.
- Altitude  $\nabla$ 2000m.
- The normal working environment temperature is  $-15^{\circ}\text{C} \sim +60^{\circ}\text{C}$ .
- Pollution grade: Level 3.
- Protection grade: IP20.
- The magnetic field strength of the external magnetic field at the installation site in any direction should not exceed 5 times that of the earth's magnetic field.

- The installation location should have good ventilation and heat dissipation conditions.
- The product derating factor is shown in Table 1-1.
- See Table 1-2 for the derating factor at high altitude.

Table 1-1: Molded case circuit breaker derating factor table

Frame Rated Current	Temperature Corresponding Product Derating Factor Table				
	40°C	45°C	50°C	55°C	60°C
125A	1	1	0.96	0.92	0.88
250A	1	1	0.96	0.92	0.88
400A	1	1	1	0.98	0.96
630A	1	0.96	0.92	0.88	0.84

Table 1-2: Molded case circuit breaker high altitude derating factor table

Altitude (m)	2000	2500	3000	3500	4000	4500	5000
Working Current Correction Factor	1In	1In	0.98In	0.97In	0.95In	0.94In	0.93In
Maximum Working Voltage (V) (125A&250A)	400	400	360	330	300	270	240
Maximum Working Voltage (V) (400V&630V)	415	415	375	345	315	285	255
Power Frequency Withstand Voltage (V)	3500	3500	3150	3000	2800	2650	2500
Insulation Voltage (V)	1000	1000	900	840	780	730	670

## 2 Communication

### 2.1 Methods

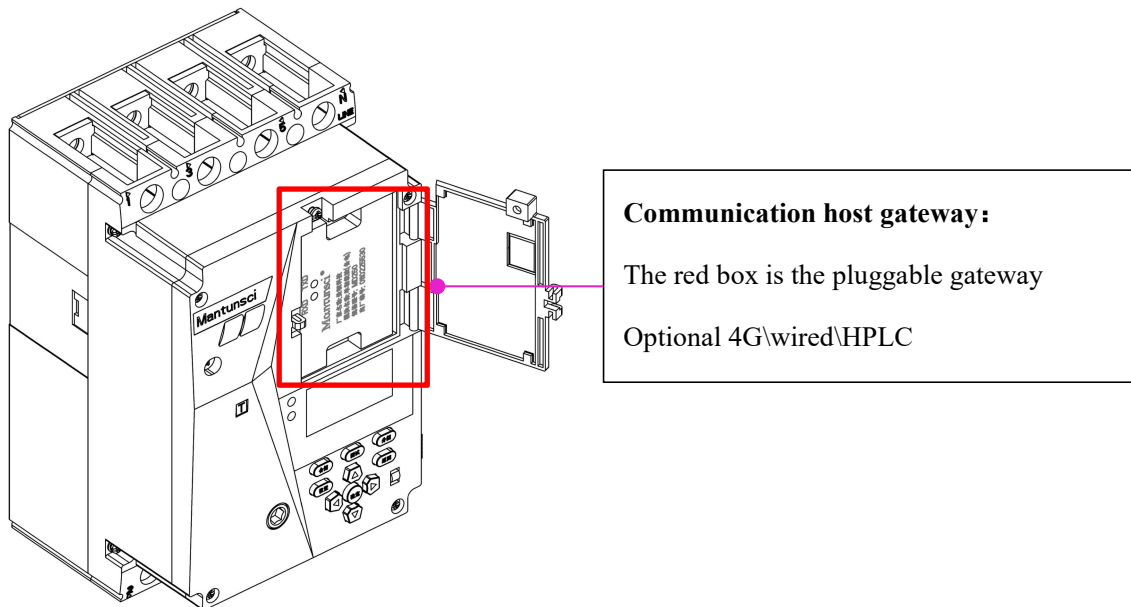

*Diagram 2-1*

Choose one of the two communication schemes, **the communication host S3-T30 series and S3-ELS converter**. As shown in Diagram 2-2 and 2-3:

**Option 1:** The communication host (Internet of Things gateway) is: S3-T30 series (rail mounting type) + S3-ELS converter. (recommend)

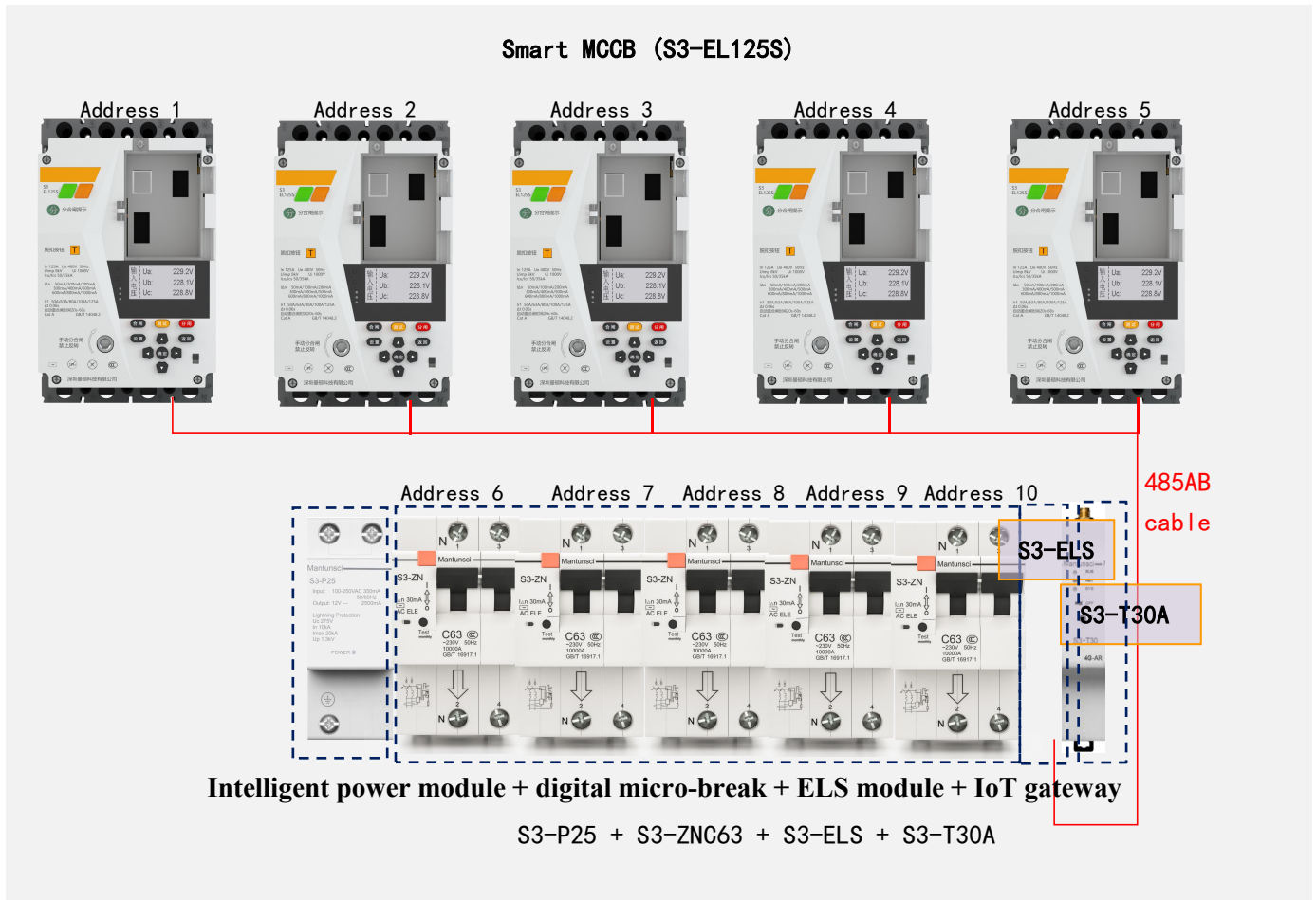

Note:

- Here we take [smart MCCB (5 pcs) + smart MCB (5 pcs)] as an example, smart MCCB takes 125A as an example, smart MCB takes 2P with leakage protection 63A as an example, and IoT gateway is S3-T30A, the power module is S3-P25, namely S3-EL125S\*5+S3-ZNC63\*5+S3-ELS+S3-T30A+S3-P25.
- One [smart power module] can carry up to 10 pieces [smart MCB] (When the smart MCB is added, more power modules can be configured), and one [IoT gateway] can carry up to 30 pieces [smart MCB]+[smart MCCB].
- All the 485AB cable of [MCCB] are connected in parallel to the AB lines of the [ELS module] in a bus type (a single branch does not exceed 20cm), and the power module + MCB + ELS module + IoT gateway are connected by 6PIN.
- All external communication ports of S3-EL125S should be configured as “MCB Protocol”.

**Option 2:** The communication host is S3-T30-4GC-ELW+ELS Converter. (optional)

**Smart MCCB (S3-EL125S)**

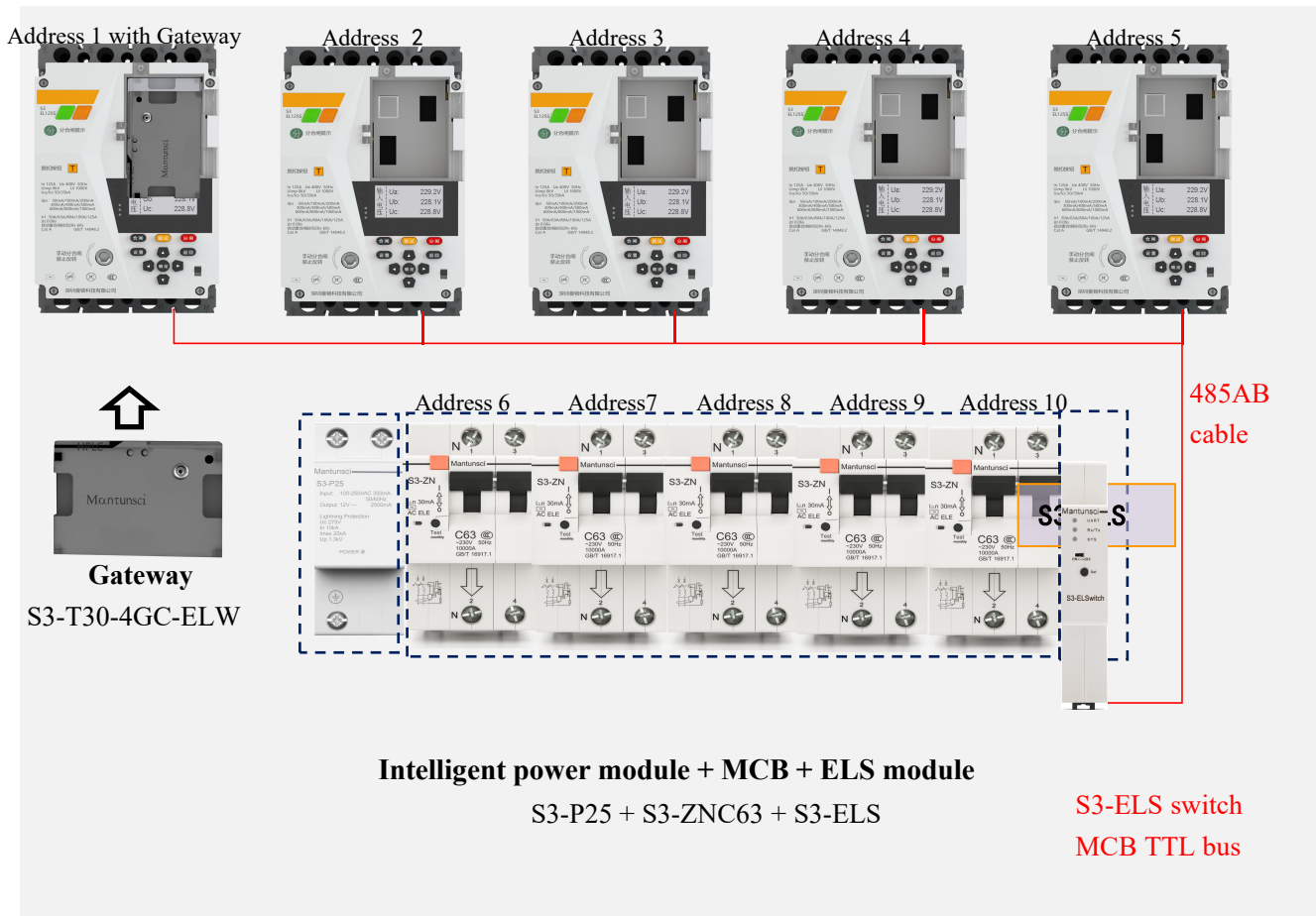

Diagram 2-3

Note:

- Here we take [smart MCCB (5 pcs) + smart MCB (5 pcs)] as an example, smart MCCB takes 125A as an example, smart MCB takes 2P with leakage protection 63A as an example, and IoT gateway is S3-T30-4GC-ELW, the power module is S3-P25, namely S3-EL125S\*5+S3-ZNC63\*5+ S3-ELS+S3-T30-4GC-ELW+S3-P25.
- One [smart power module] can carry up to 10 pieces [smart MCB] (When the smart MCB is added, more power modules can be configured), and one [IoT gateway] can carry up to 30 pieces [smart MCB]+[smart MCCB].
- All the 485AB cable of [MCCB] are connected in parallel to the AB lines of the [ELS module] in a bus type (a single branch does not exceed 20cm), and the power module + MCB + ELS module + IoT gateway are connected by 6PIN.

- The external communication port of S3-EL125S at address 1 needs to be configured as “mapping mode”, and the internal port needs to be configured as “MCB protocol”.
- The external communication port of S3-EL125S at address 2~address 5 should be configured as “MCB Protocol”.

## **2.2 Communication Function Description**

According to communication requirements, standard HPLC, 4G, net port and other communication modules developed by our company can be inserted.

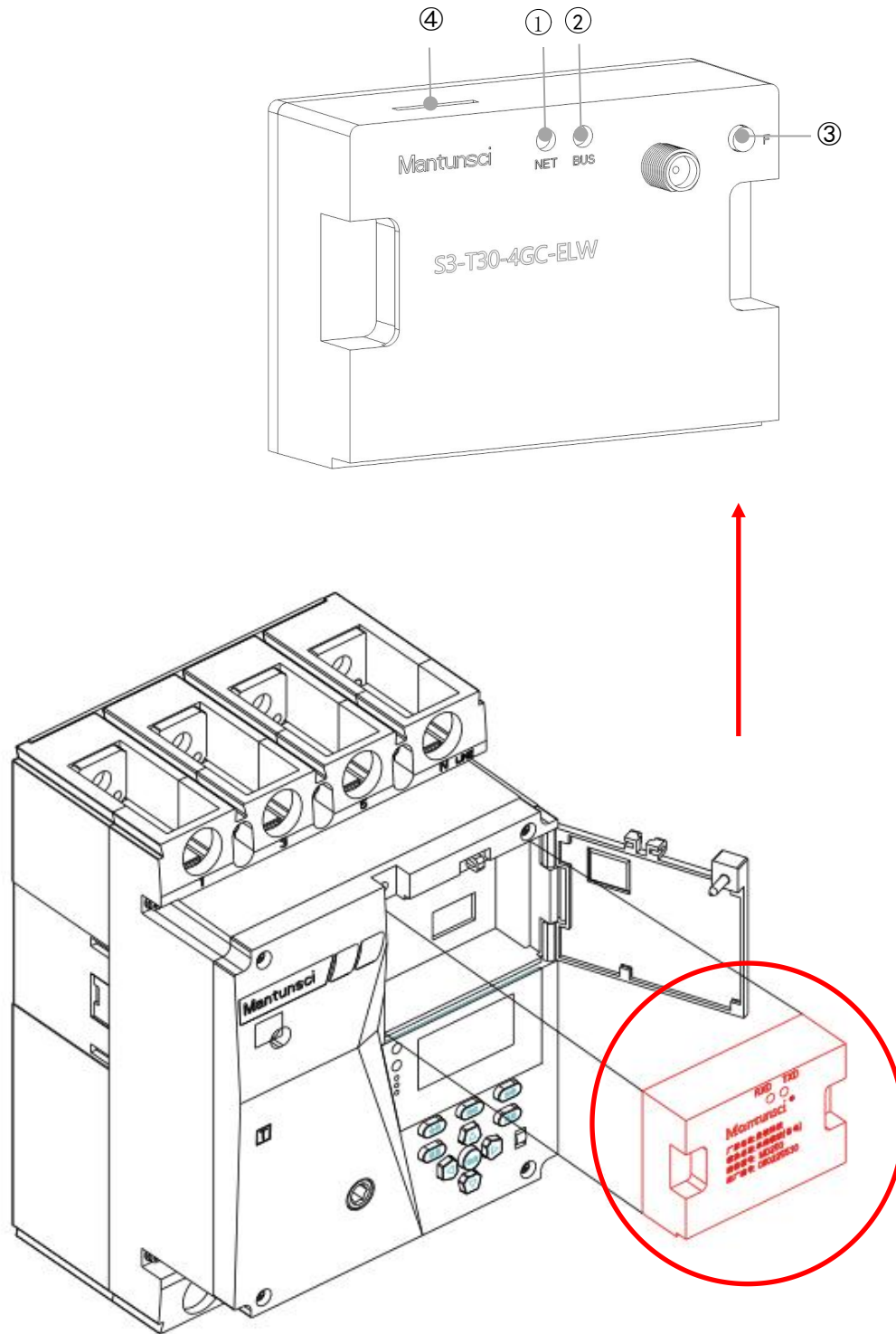

Diagram 2-4

Table 2-1:

No.	Way of Communication	4G+WIFI (WIFI by default)	WAN+WIFI (WIFI by default)	HPLC
①	Indicator NET	Flashing: connecting On: connected Off: disconnected	Flashing: connecting On: connected Off: disconnected	For the standard HPLC module, please refer to the State Grid HPLC description
②	Indicator BUS	Flashing: connecting Off: disconnected	Flashing: connecting Off: disconnected	For the standard HPLC module, please refer to the State Grid HPLC description
③	F button	Set WIFI Hotspot	Set WIFI Hotspot	None
④	SIM card	SIM card is required, see 2.3 for card insertion instructions	None	None

## 2.3 SIM Card Pluggable Instructions

If you use a SIM IoT card to connect to the Internet, please additionally register the serial number on the back of the **SIM card**.

When inserting the card, please pay attention to insert the card into the slot parallel to the **SIM card notch direction** and the **metal chip direction** as shown in the figure below, until you feel the elasticity at the bottom of the card slot. When pulling out the card, press the SIM card in the card slot to eject it.

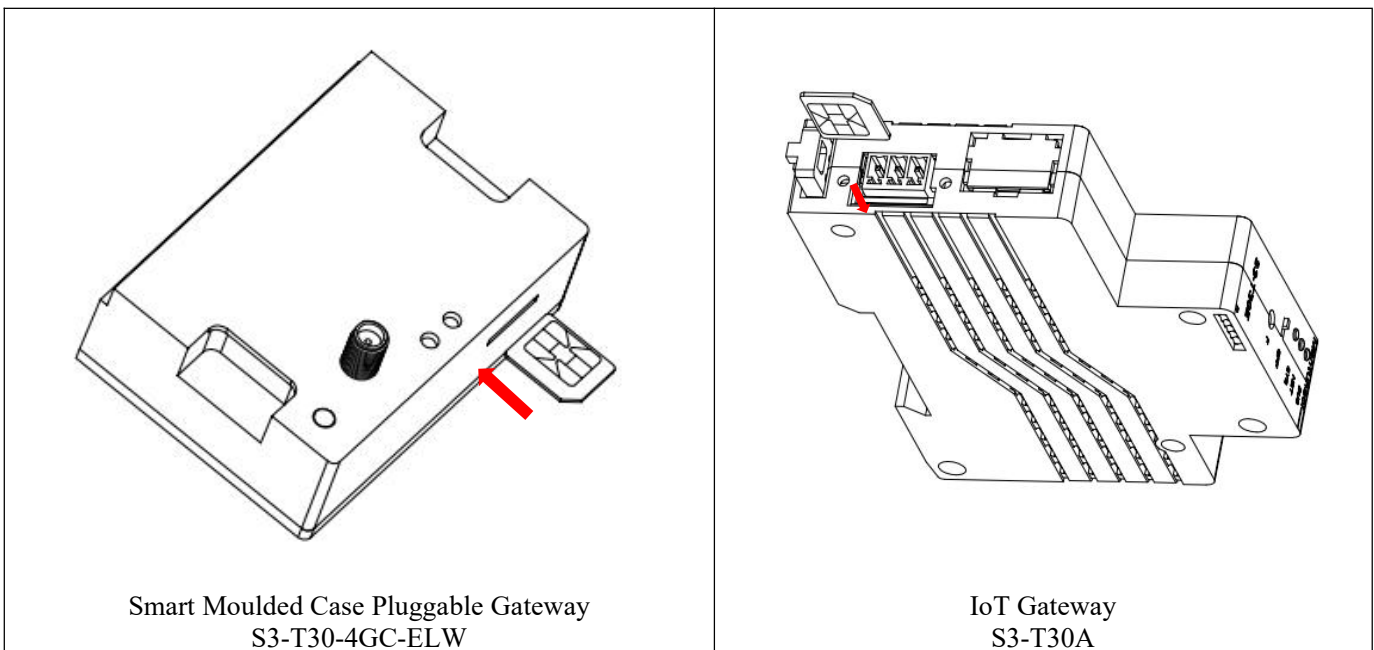

Diagram 2-5 Card Insertion Diagram

## 2.4 External Pluggable Terminals

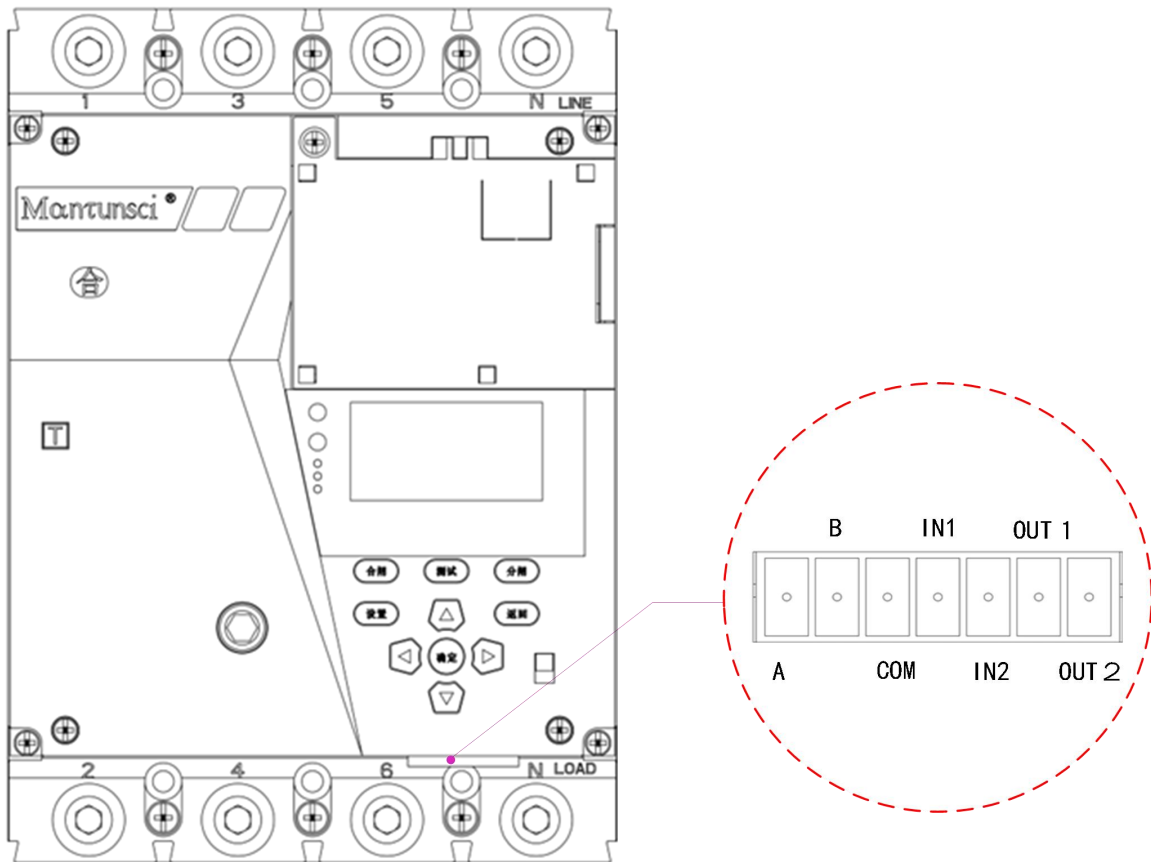

Diagram 2-6 External Pluggable Terminals (S3-EL250S)

Table 2-2: External Pluggable Terminals (from left to right)

A	B	COM	IN1	IN2	OUT1	OUT2
RS485 interface		Common port	External open dry contact input/active and reactive pulse output	External close dry contact input/second pulse output	Multi-function open-drain output1/ alarm input 1	Multi-function open-drain output 2/ alarm input 2

Communication Interface	External Terminal	Communication Protocol	Communication Rate
RS485 interface	A/B	DL/T-645 485 protocol Bus mapping MCB protocol	300-115200(adjustable)

## 2.5 CAN Bus Interface

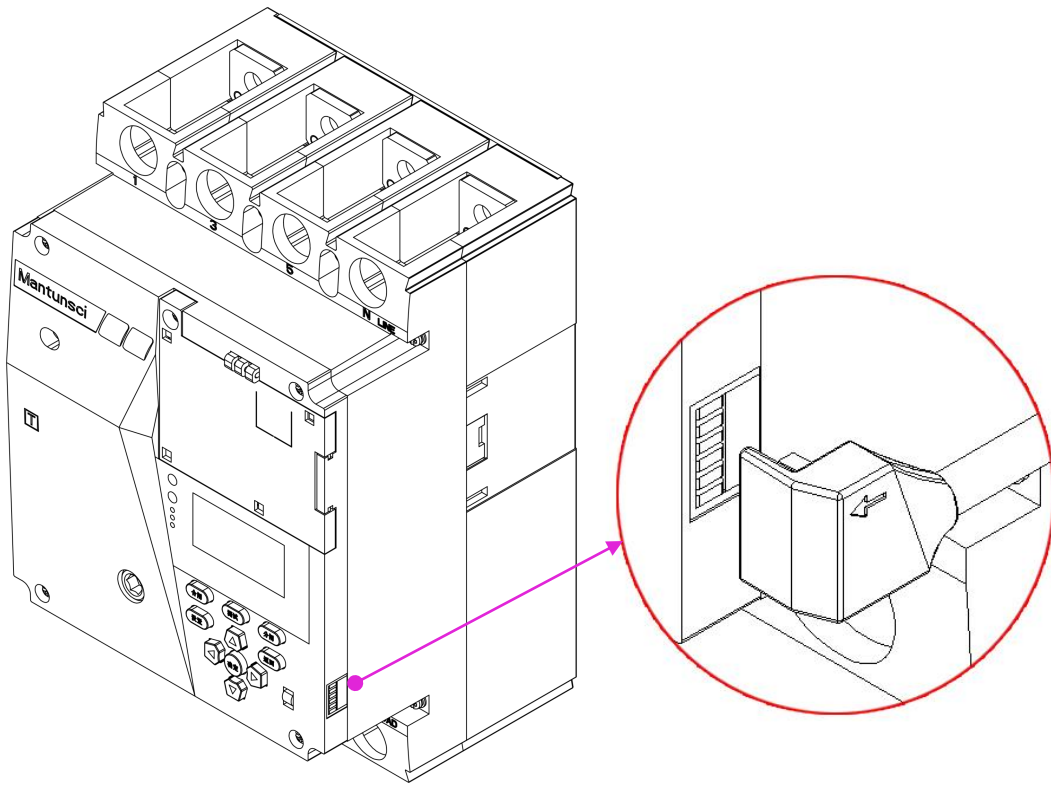

Diagram 2-7 Bus Interface(S3-EL250S)

## 3 Technical Parameters

Table 3-1: Performance

Items	Specifications			
	S3EL-125S	S3EL-250S	S3EL-400S	S3EL-630S
Frame Current	125A	250A	400A	630A
Poles	3P+N			
Rated Voltage Ue	AC 400V 50Hz		AC 415V 50Hz	
Rated Insulation Voltage Ui	AC 1000V			
Rated Impulse Withstand Voltage Uimp	8000V			
Arcing Distance	≥ 50mm	≥ 50mm	≥ 100mm	≥ 100mm
Ultimate short-circuit breaking capacity Icu	50kA	50kA	85kA	85kA
Operating Short-circuit Breaking Capacity Ics	35kA	35kA	65kA	65kA

<b>Rated Residual Short-circuit Making (Breaking) Capacity <math>I_{\Delta m}</math></b>		12.5kA	12.5kA	16.25kA	16.25kA
<b>Residual Current Operating Characteristics</b>		AC type			
<b>Rated Residual Operating Current <math>I_{\Delta n}</math></b>		30mA, 50mA, 75mA, 100mA, 150mA, 200mA, 300mA, 400mA, 500mA, 600mA, 800mA, 1000mA, Auto, OFF			
<b>Residual Action Time Characteristics</b>		Delay type			
<b>Delay Type Limit Non-driving Time</b>		2I $\Delta$ n:0.06s			
<b>Auto Reclosing Time</b>		20~60s			
<b>Operational Performance (times)</b>	<b>Electrical life</b>	1500	1000	1000	1000
	<b>Mechanical life</b>	8500	7000	4000	4000
	<b>Total</b>	10000	8000	5000	5000
<b>Overload and Short Circuit Characteristics</b>		Three-stage protection, electronically adjustable, see “Protection Features Description” for details			
<b>Joint Control Delay Time</b>		$\leq 3000$ ms			
<b>Communication Delay Time</b>		$\leq 500$ ms			
<b>Basic Function</b>		Remote ON/OFF control; high-precision electrical parameter measurement function; power quality analysis function; waveform display function; fault record statistics function; remote signaling, remote adjustment, remote control, and telemetry			
<b>General Protection Function</b>		Split-phase short-circuit protection; split-phase inverse time overcurrent protection; split-phase/summed power overload protection; upper and lower terminal temperature over-temperature alarm, warning; phase loss; phase sequence; three-phase unbalance; overvoltage and undervoltage warning, alarm; leakage current protection; field setting current			
<b>Measurement Accuracy</b>		Voltage, current, power level 0.5; energy metering level 1			
<b>PV Grid-connected Protection Function</b>		Island judgment, power failure and disconnection, monitoring grid status recloser, sharp, peak, shoulder, off-peak statistics			

Table 3-2: Alarm parameters

Alarms	Set Range				Default Value				Whether Alarm/Warning is Enabled (Default)	Whether OFF is Enabled (Default)	Whether Recloser is Enabled (Default)
	S3EL-125S	S3EL-250S	S3EL-400S	S3EL-630S	S3EL-125S	S3EL-250S	S3EL-400S	S3EL-630S	All models	All models	All models
Overvoltage Delay	100ms~10000ms				5000ms				Yes	Yes	No
Overvoltage alarm	100V~350V				275V						
Overvoltage warning	100V~350V				240V						
Undervoltage delay	100ms~15000ms				5000ms				No	No	No
Undervoltage alarm	80V~220V				165V						
Undervoltage warning	80V~220V				200V						
Overcurrent Alarm	5A~150A	5A~300A	5A~480A	5A~756A	150A	250	480A	756A	Yes	Yes	No
Overcurrent Warning	5A~125A	5A~250A	5A~400A	5A~630A	100A	200A	320A	504A			
Inverse Time Alarm Delay	3s~18s				5s						
Overcurrent Alarm elay	3s~15s				5s						

<b>Rated Current Ir1</b>	50A 63A 80A 100A 125A	100A 125A 140A 160A 180A 200A 225A 250A	225A 250A 315A 350A 400A	400A 500A 630A	125A	250A	400A	630A			
<b>Inverse time parameter</b>	1~3				2						
<b>Instantaneous Short Circuit Ir3</b>	4Ir1~14Ir1				10Ir1				Yes	Yes	No
<b>Delay Short Circuit Ir2</b>	2Ir1~12Ir1				6Ir1						
<b>Delay Short Circuit Delay</b>	100ms~1000ms				500ms						
<b>Shunt Overload</b>	100W~27.5kW	100W~55kW	No	No	No	55kW	88kW	138.65kW	No	No	No
<b>Bus Overload</b>	300W~82.5kW	300W~165kW	300W~264kW	300W~415.8kW	82.5kW	165kW	264kW	415.8kW			
<b>Overload Delay</b>	3s~15s				10s						
<b>Over Temperature Alarm</b>	10°C~140°C				90°C				Yes	Yes	No
<b>Over Temperature Warning</b>	10°C~112°C				70°C						
<b>Over Temperature Delay</b>	3~15s				5s						
<b>Residual Alarm</b>	30mA, 50mA, 75mA, 100mA, 150mA, 200mA, 300mA, 400mA, 500mA, 600mA, 700mA, 800mA, 900mA, 1000mA				500mA				Yes	Yes	No
<b>Residual Delay</b>	50ms~3000ms				500ms						
<b>Residual</b>	15ms~1000mA				400mA						

<b>Warning</b>					
<b>Current Phase Loss Threshold Current</b>	0.5A~30A	0.5A	No	No	No
<b>Current Phase Loss Delay</b>	3s~15s	5s			
<b>Voltage Phase Loss Threshold Voltage</b>	10V~50V	30V	No	No	No
<b>Voltage Phase Loss Delay</b>	3 s~15s	5s			
<b>Unbalanced Alarm</b>	2%~100%	30%	No	No	No
<b>Unbalanced Alarm Delay</b>	3s~15s	5s			
<b>Reverse Phase Sequence Alarm Delay</b>	3s~15s	5s	No	No	No
<b>Total Harmonic Distortion Alarm</b>	2%~100%	20%	No	No	No
<b>Harmonic Distortion Delay</b>	3s~15s	5s			

Table 3-3: Island Identification Parameters

Island Identification Item	Swing Range	Default Value	Default Status	Whether Alarm/Warning is Enabled (Default)	Whether OFF is Enabled (Default)
	All models	All models	All models	All models	All models
<b>Voltage Amplitude Swing</b>	10%Un~40%Un (Un=220V)	Un±20% (Un=220V)	OFF	No	No

Island Identification Item	Swing Range	Default Value	Default Status	Whether Alarm/ Warning is Enabled (Default)	Whether OFF is Enabled (Default)
	All models	All models	All models	All models	All models
<b>Voltage Frequency Swing</b>	$F_s \pm 0.2\text{Hz} \sim F_s \pm 1.5\text{Hz}$ ( $F_s = 50\text{Hz}$ )	$F_s \pm 0.2\text{Hz}$ ( $F_s = 50\text{Hz}$ )	OFF		
<b>Voltage Phase Swing</b>	$2^\circ \sim 30^\circ$	$10^\circ$	OFF		
<b>Voltage Waveform Distortion Rate Swing</b>	$5\% \sim 30\%$	$10\%$	OFF		
<b>Delay Action Characteristic is Definite Time</b>	$1\text{s} \sim 15\text{s}$	$1\text{s}$	/		
<b>Detection Time</b>	$0.3\text{s} \sim 3\text{s}$	$0.5\text{s}$	/		

## 4 Protection Characteristics

### 4.1 Overload Long Delay Protection

#### 4.1.1 Action Threshold Setting Range

Table 4-1: Overload long delay parameter setting

Parameters	Frame Current	Setting Value	Factory Setting
Action Threshold Setting Range Ir1	125	50A, 63A, 80A, 100A, 125A	125A
	250	125A, 140A, 160A, 180A, 200A, 225A, 250A	250A
	400	225A, 250A, 315A, 350A, 400A	400A
	630	400A, 500A, 630A	630A
Delay Time Set Threshold (2Ir1)	/	3s, 4s, 6s, 8s, 10s, 12s, 14s, 16s, 18s, OFF	5s

#### 4.1.2 Action Characteristics

Table 4-2: Protection Action Characteristics

Rated Current (A)	1.05Ir1 (Cold State) Non-action Time (h)	1.3Ir1 (Hot State) Action Time (h)
$50 \leq Ir1 \leq 63$	1	$\leq 1$
$63 < Ir1 \leq 630$	2	$\leq 2$

#### 4.1.3 Delay Characteristics

The overload protection meets the following formula according to the inverse time characteristic, and the delay accuracy is:  $\pm 10\%$

$$T = \frac{K}{\left(\frac{I}{I_{set}}\right)^a - 1}$$

Among them:

T is the action time value, the default is 5 seconds.

Iset is the rated current Ir1.

a is the inverse time parameter, the default is 2.

I is the current fault current value.

K is an internal constant.

**Note:** The fault current I for reliable operation must be greater than 1.3Ir1.

## 4.2 Short Circuit Short Delay Protection

### 4.2.1 Short Circuit Short Delay Protection Related Parameter Setting

Table 4-3: Short circuit short delay protection parameter setting

Parameter Setting	Setting Value	Factory Setting
Short delay action current setting value Ir2	2Ir1, 3Ir1, 4Ir1, 5Ir1, 6Ir1, 7Ir1, 8Ir1, 9Ir1, 10Ir1, 11Ir1, 12Ir1	6Ir1
Short delay time setting value ts	0.1s, 0.2s, 0.3s, 0.4s, 0.5s, 0.6s, 0.7s, 0.8s, 0.9s, 1.0s, OFF	0.4s

### 4.2.2 Short-circuit Short-time Delay Protection Action Characteristics

Table 4-4: Short-circuit short-time delay protection action characteristics

Short-circuit Short-time Delay Protection Current Setting Value	Tripping Current Accuracy	Delay Error
Ir2	(1 ± 20%) Ir2	± 40ms

## 4.3 Instantaneous protection

### 4.3.1 Short-circuit Instantaneous Protection Related Parameter Settings

Table 4-5: Instantaneous parameter settings

Parameter Setting	Setting Value	Factory Setting
Instantaneous operating current setting value Ir3	4Ir1, 5Ir1, 6Ir1, 7Ir1, 8Ir1, 9Ir1, 10Ir1, 11Ir1, 12Ir1, 13Ir1, 14Ir1, OFF	10Ir1

### 4.3.2 Short-circuit Instantaneous Protection Action Characteristics

Table 4-6: Instantaneous action characteristics

Instantaneous Protection Current Setting Value	Tripping Current Accuracy	Delay Error
Ir3	$(1 \pm 20\%) Ir3$	$\pm 40ms$

## 4.4 Residual Current Protection

### 4.4.1 Action characteristics

Table 4-7: Residual current action characteristics

Parameter	Characteristics				
Residual operating current $I \Delta n$	Setting value: 30mA, 50mA, 75mA, 100mA, 150mA, 200mA, 300mA, 400mA, 500mA, 600mA, 800mA, 1000mA, OFF, Auto			Setting value: 500mA	
Rated non-operating Current $I \Delta no$	$0.5I \Delta n$				
Delay characteristics	2 $I \Delta n$ Limit non-driving time ( $\Delta t$ )	Breaking time			
		$I \Delta n$	2 $I \Delta n$	5 $I \Delta n$	10 $I \Delta n$
Non-delay	-	$\leq 0.3s$	$\leq 0.15s$	$\leq 0.06s$	
Delay	$\geq 0.06s$	$\leq 0.5s$	$\leq 0.2s$	$\leq 0.15s$	

### 4.4.2 Automatic Gear Mode

Table 4-8: Each gear value and floating value in automatic gear mode

Gear Value (mA)	200	300	400	500
-----------------	-----	-----	-----	-----

<b>Floating Value (mA)</b>	100	150	200	/
----------------------------	-----	-----	-----	---

When the residual current is greater than the floating value of the gear but does not reach its action value and remains stable for 60s, the gear will float up by one gear, and so on, until the maximum gear; when the residual current is less than the floating value of the next gear of the gear and maintains it stably for 120s, the gear will float down by one gear, and so on until the minimum gear.

Take the “Auto” gear as an example, the initial residual current of the line is 100mA. The circuit breaker is power-on, and the gear is automatically set to 300mA. When the residual current increases to above 150mA and stabilizes for 60s, the gear changes to 400mA; when the residual current decreases to below 100mA and stabilizes for 120s, the gear changes to 200mA.

#### 4.4.3 Automatic reclosing

**Automatic reclosing:** When the residual current exceeds the operating current value, the gear will automatically reclose after 20 to 60 seconds, but the manual close is not limited by time.

**Lock:** The lock time is 5s, that is, when the leakage fault occurs again within 5s after the product is reclosed, the circuit breaker trips and locks again within the operating time, the device cannot be automatically reclosed, and must be closed manually; In the event of leakage fault, the circuit breaker will trip without locking within the operating time, and will automatically reclose again after 20 to 60 seconds.

## 4.5 Overvoltage Protection

When the line phase voltage is higher than the overvoltage protection setting value, the circuit breaker protection trips. When the line voltage returns to normal voltage, the circuit breaker can be automatically closed and put into operation. The setting range of overvoltage protection is 100V~350V, and the default value is shown in Table 3-2. Users can set or disable the protection by themselves.

## 4.6 Undervoltage Protection

When the line phase voltage is lower than the undervoltage protection setting value, the circuit breaker protection trips. When the line voltage returns to normal voltage, the circuit breaker can be automatically closed and put into operation. The setting value range of undervoltage protection is 80V~220V, and the default value is shown in Table 3-2.

Users can set or disable the protection by themselves.

## 4.7 Phase Loss Protection

The circuit breaker protection trips when there is a phase loss at the line power end. When the line returns to normal voltage, it can be automatically closed and put into operation. The factory default setting is OFF.

## 4.8 Linkage Protection

Through the linkage interface, the linkage protection with other fire devices can be carried out as follows:

Table 4-9:

DI Input Setting		Function	Priority	Delay Time (ms)
Input control	Connect IN1 with COM	Close	Low	≤500ms
	Connect IN3 with COM	Open	High	

Note:

- 1) The external input should be in pulse mode, and the width should be greater than 50ms (short-circuit time). Do not short-circuit for a long time, otherwise the circuit breaker will always be in the open or close status.
- 2) It is necessary to enable the corresponding closing and opening input function in System Settings -> Other Settings.

## 4.9 Island Protection

Island refers to that when the power grid is interrupted due to electrical fault, misoperation or natural factors, the power generation system fails to detect the power outage in time and disconnects from the power grid, so that the power generation system and surrounding loads form a self-supply power supply system that the power company cannot control. When the power generation system is connected to the grid, if it is in the island status, it will cause damage to the device. It affects the safe and normal operation of the power system, and may even threaten the personal safety of line maintenance personnel in severe cases.

**Island judgment:** when any of the detected voltage amplitude swing/frequency swing/phase swing/distortion swing is greater than the set threshold, it is determined as an island. See Table 3-3 for specific parameters.

## 5 Tripping Curve

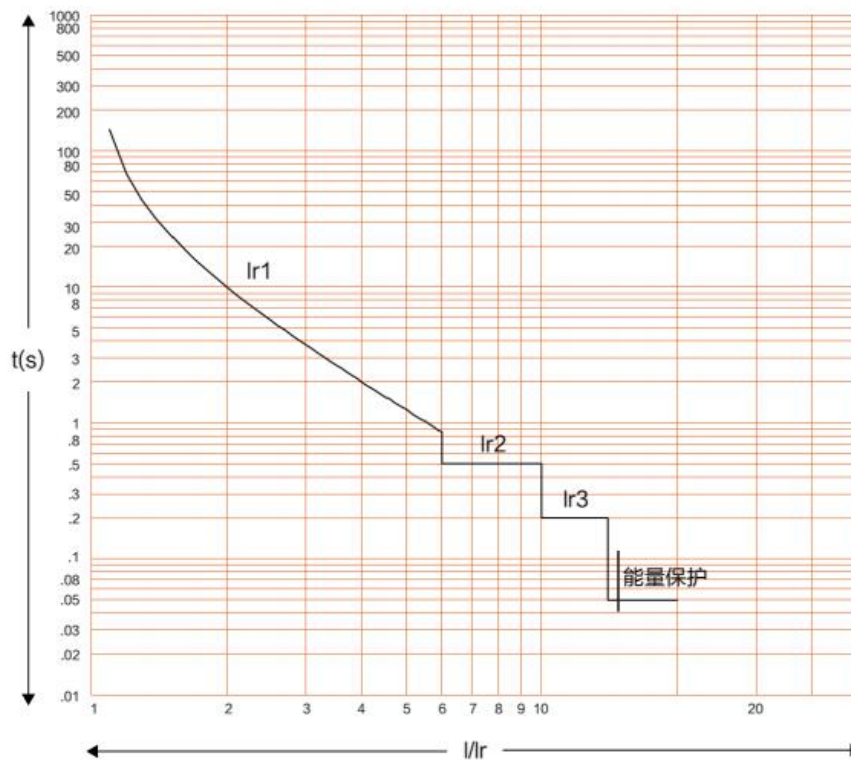

Diagram 5-1 tripping curve

## 6 Installation and Operation

### 6.1 Installation Precautions

- Before installation, please check whether the product specifications and models are correct and whether the accessories are complete.
- Please read this instruction manual carefully to ensure correct installation and routine maintenance.
- The product must be installed vertically.
- Select the appropriate wire according to the rated current of the product and related standards, and wire in strict accordance with the regulations. The top is the power supply terminal, 1, 3, and 5 are respectively connected to A, B, and C phases, and N is connected to the neutral line. The bottom is the load end, 2, 4, and 6 are respectively connected to A, B, and C phases, and N is connected to the neutral line.
- The cross-sectional area of the incoming and outgoing wires should meet the construction requirements specified in the standard, and the conductive parts are not allowed to be exposed beyond the casing.

- Please install the arc shield correctly after wiring.
- Install it in a place out of the reach of non-electricians and minors to prevent electric shock or change the correct configuration and wiring of the product.

## 6.2 Operation

The circuit breaker has a power-on test function (can be turned off), which can effectively prevent the safety hazards of subsequent equipment. The product buttons are shown below.

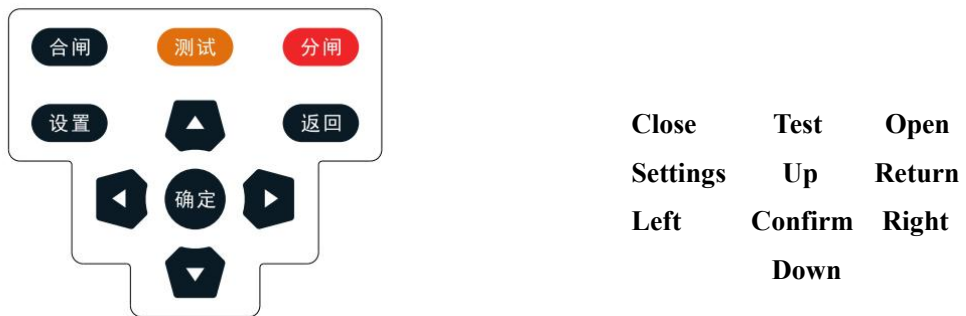

Diagram 6-1 MCCB buttons

### 6.2.1 Product Test Run

After the wiring is completed, turn on the circuit breaker after checking that it is correct. The circuit breaker is in the breaking status, set the parameters according to the operating instructions, and after the setting is completed, perform the close operation, and the running status is shown in Diagram 6-2.

vo	Ua:	220.0V	cu	Ia:	100.00A	ac	Pa:	22Kw
lta	Ub:	220.0V	rr	Ib:	100.00A	ti	Pb:	22Kw
ge	Uc:	220.0V	en	Ic:	100.00A	ve	Pc:	22Kw
			t	In:	0.00A		Ps:	66Kw
re	Qa:	0Var	ap	Sa:	22VA	to	Ea:	1000.00Kwh
ac	Qb:	0Var	pa	Sb:	22VA	ta	Eb:	1000.00Kwh
ti	Qc:	0Var	re	Sc:	22VA	l	Ec:	1000.00Kwh
ve	Qs:	0Var	nt	Ss:	66VA		Es:	3000.00Kwh

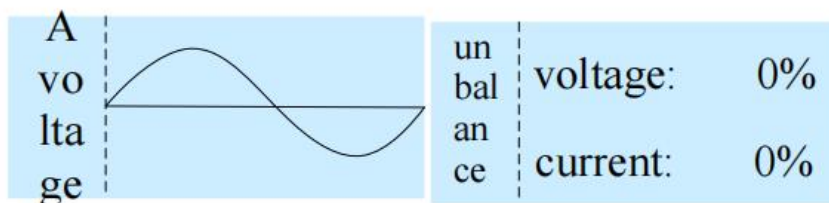
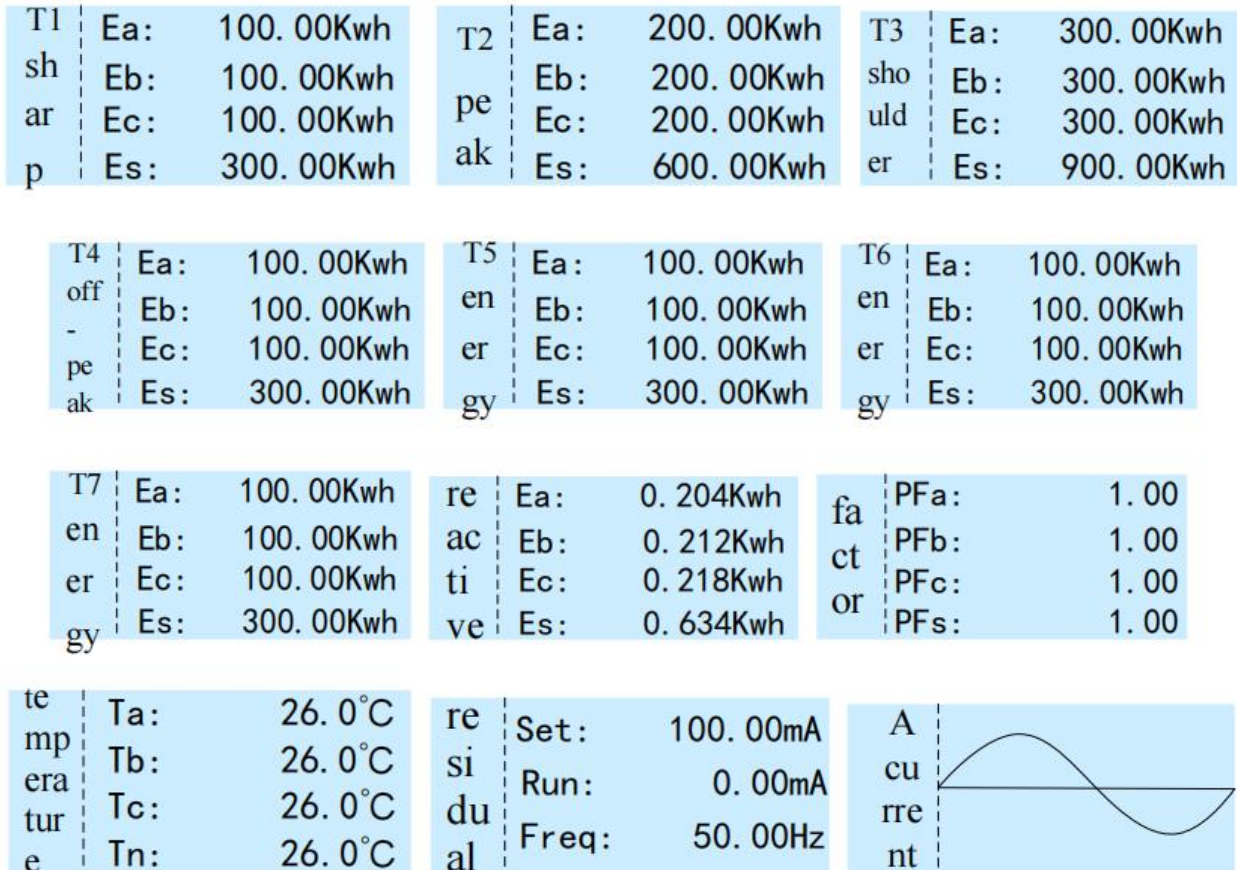

Diagram 6-2 ON status carousel display (configurable display data)

In the ON state, press the [Test] button to test the residual current, and it can be reclosed within 20s-60s.



Diagram 6-3

## 6.2.2 Close operation of the circuit breaker

### (1) Auto close

Press the [ON] button for 0.5 seconds, and the LCD screen displays "Close..". After the close is successful, the

LCD screen is displayed as "***Close and Operating***", and the circuit breaker enters the normal operation status.

### **(2) Manual close**

Make sure the circuit breaker is open, insert the Allen wrench into the hole and turn clockwise until the upper-left corner ON/OFF indicator shows the word "ON". After the close is successful, the LCD screen status is automatically updated to the "***Close and Operating***", and the circuit breaker enters the normal operation status.

**Note: Only manual close can be performed when the power supply end of the circuit breaker and the main contact is disconnected. The closing operation is shown in the above method (2).**

## **6.2.3 Open operation of the circuit breaker**

### **(1) Auto open**

Insert the wrench into the hole and turn clockwise until the ON/OFF indicator in the upper left corner shows "OFF". After the opening is successful, the LCD status is displayed as "***Open and Standby***".

### **(2) Auto close**

In the operating status, press the [OFF] button for 0.5 seconds, a "bleep" prompt sound can be heard, and the LCD screen displays "Open...". After the opening is successful, the LCD status is displayed as "***Open and Standby***".

# **7 Operation Instructions**

## **7.1 Main Menu**

Click the [Set] button, enter the default password "1111", and enter the main menu. In the main menu, press the [OK] button can enter the following menus:

- (1) Parameter settings: a number of key electrical parameter settings.
- (2) System settings: various device function settings.
- (3) Query records: multiple historical queries.
- (4) Operation and maintenance: necessary monitoring, repair and maintenance of device and systems.
- (5) Energy analysis: fine waveform analysis of electrical energy.
- (6) About: Device version information and service information description.

Main Menu	Main Menu	Main Menu
1. parameter settings ...	1. parameter settings ...	4. operation and maintenance...
2. system settings ...	2. system settings ...	5. energy analysis ...
3. query records ...	3. query records ...	6. about ...

Diagram 7-1 main menu interface

As shown in Diagram 7-1, in the real-time display status:

[Set] button to enter the main menu interface, a total of 6 submenus.

[Up/Down] button to control the reverse video position.

[OK] button to enter the corresponding submenu.

## 7.2 Parameter settings

Parameter settings: The system closely monitors the electrical status of the line, provides automatic protection for over and under voltage, overload, overcurrent, over temperature, short circuit, phase loss, etc., and the protection range is adjustable, and the data can be set and modified according to different needs.

Main Menu
1. parameter settings ...
2. system settings ...
3. query records ...

Diagram 7-2

As shown in Figure 7-2, click [OK] to enter [Parameter Settings].

Parameter Settings	Parameter Settings
1. overvoltage settings: ...	4. overload settings: ...
2. undervoltage settings: ...	5. over-temperature settings: ...
3. overcurrent settings: ...	6. short-circuit settings: ...

Parameter Settings	Parameter Settings	Parameter Settings
7. residual current: ...	10. unbalance: ...	12. external output alarm: ...
8. voltage phase loss: ...	11. reverse phase sequence: ...	13. island identification: ...
9. current phase loss: ...	12. external output alarm: ...	14. output live protection: ...

Diagram 7-3 parameter settings

As shown in Diagram 7-3, enter the [Parameter Settings] submenu:

[Up/Down] button to control the reverse video position or page turning.

[OK] button to enter the corresponding settings menu.

[Return] button to return to the previous menu.

### 7.2.1 Overvoltage Settings

Overvoltage setting: set the maximum voltage for warnings and alarms.

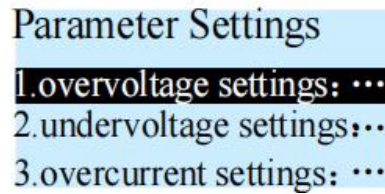

Diagram 7-4

As shown in Diagram 7-4 above, press the [OK] button to enter [Overvoltage Settings].

Overvoltage Settings	Overvoltage Settings	Overvoltage Settings
1.recloser: OFF	4.alarm trip: ON	5.alarm: ON
2.alarm value: 275.0V	5.alarm: ON	6.alarm delay: 5.00S
3.warning value: 240.0V	6.alarm delay: 5.00S	7.warning: ON

Diagram 7-5 overvoltage settings

As shown in Diagram 7-5, enter [Overvoltage Settings]:

[Up/Down] button to control the reverse video position or adjust the parameters.

[Left/Right] button to control the position of the parameter digit reverse video.

[OK] button to enter the corresponding settings menu/toggle setting options.

[Return] button to return to the previous menu.

Note:

- Overvoltage protection can be turned off or set in the range of 100~350V.
- Recloser: after the circuit breaker trips due to overvoltage alarm, it will automatically reclose in a short time. ON or OFF can be set. (Default: OFF)
- Alarm value: set the alarm threshold, if the actual voltage value exceeds the set threshold, overvoltage event will occur. (Default: 275V)
- Warning value: set the warning threshold, if the actual voltage value exceeds the set threshold, warning signal will occur. (Default: 240V)
- Alarm tripping: the function of "ON" or "OFF" to open due to the alarm, OFF: only close the open, the alarm prompt message still exists. (Default: ON)
- Alarm function: the "ON" or "OFF" function of overvoltage protection configuration can be set, and the

overvoltage alarm configuration will be invalid if it is turned off. (Default: ON)

- Alarm delay: overvoltage event duration beyond this value will generate an overvoltage alarm. (Default: 5s)
- Warning function: the "ON" or "OFF" warning prompt can be set, and the overvoltage warning configuration will be invalid if it is turned off. (Default: ON)

### 7.2.2 Undervoltage Settings

Undervoltage settings: set the lower limit voltage of the warning and alarm.

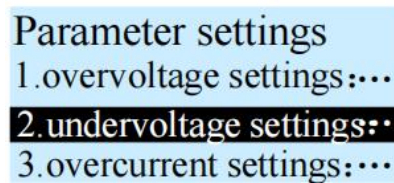

Diagram 7-6

As shown in Diagram 7-6, the [OK] button enters [Undervoltage Settings].

Undervoltage Settings	Undervoltage Settings	Undervoltage Settings
1.recloser: OFF	4.alarm trip: OFF	5.alarm: OFF
2.alarm value: 165.0V	5.alarm: OFF	6.alarm delay: 5.00S
3.warning value: 200.0V	6.alarm delay: 5.00S	7.warning: OFF

Diagram 7-7 undervoltage settings

As shown in Diagram 7-7 above, enter [Undervoltage Settings]:

[Up/Down] button to control the reverse video position or adjust the parameters.

[Left/Right] button to control the position of the parameter digit reverse video.

[OK] button to enter the corresponding settings menu/toggle setting options.

[Return] button to return to the previous menu.

Note:

- Undervoltage protection configuration: can be turned off or set in the range of 80~220V.
- Recloser: after the circuit breaker trips due to undervoltage alarm, it will automatically reclose in a short time. ON or OFF can be set. (Default: OFF)
- Alarm value: set the alarm threshold, if the actual voltage value is lower than the set threshold, undervoltage event will occur. (Default: 165V)
- Warning value: set the warning threshold, if the actual voltage value is lower than the set threshold, warning

signal will occur. (Default: 200V)

- Alarm tripping: the function of "ON" or "OFF" to open due to the undervoltage alarm, OFF: only close the open, the alarm signal still exists. (Default: OFF)
- Alarm function: the "ON" or "OFF" function of undervoltage protection configuration can be set, and the undervoltage alarm configuration will be invalid if it is turned off. (Default: OFF)
- Alarm delay: undervoltage event duration beyond this value will generate an undervoltage alarm. (Default: 5s)
- Warning function: the "ON" or "OFF" warning prompt can be set, and the overvoltage warning configuration will be invalid if it is turned off. (Default: OFF)

### 7.2.3 Overcurrent Settings

Overcurrent settings: set overcurrent protection switch, warning and alarm.

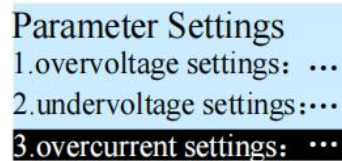
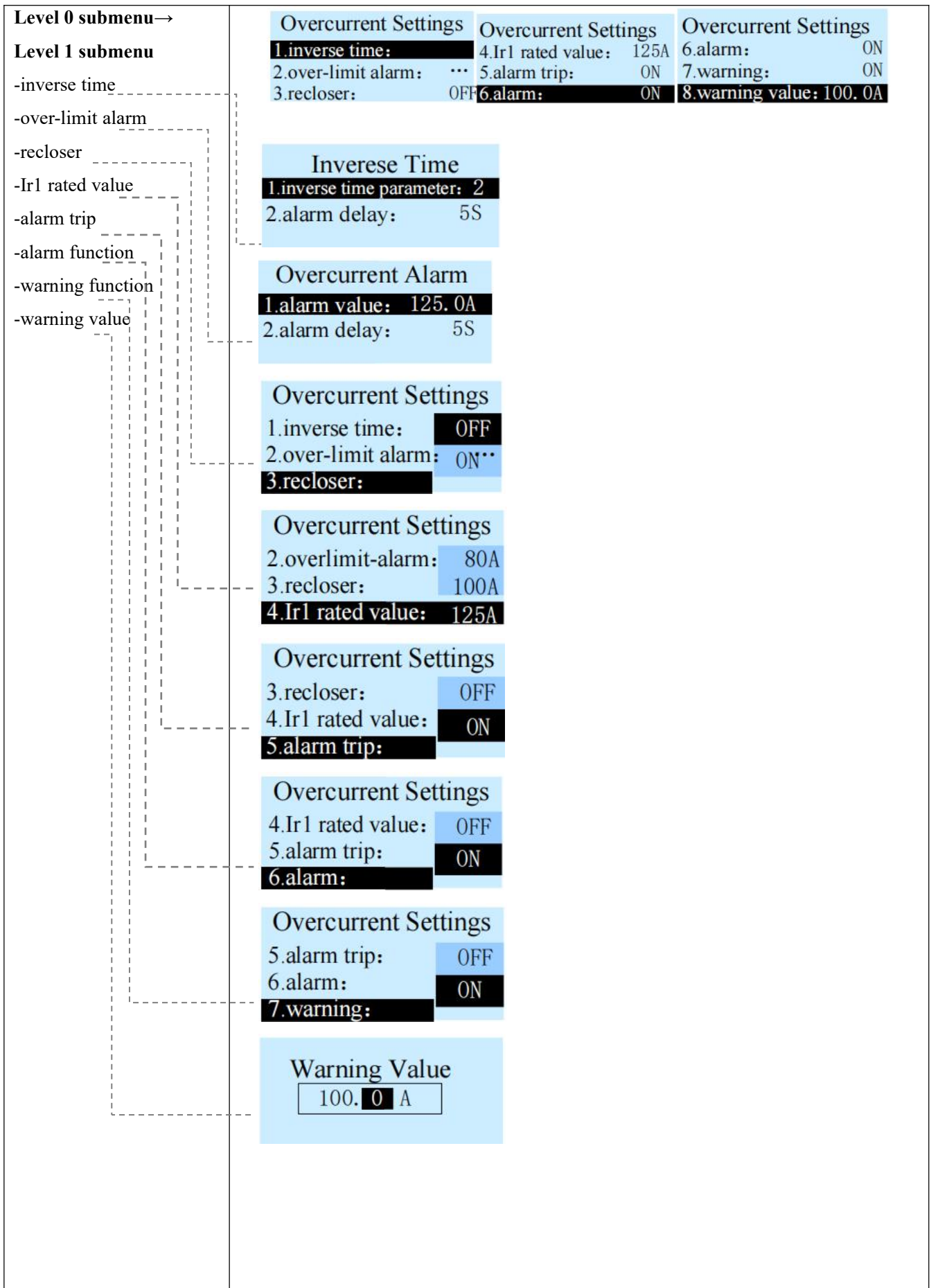

Diagram 7-8

As shown in Diagram 7-8 above, the [OK] button enters [Overcurrent Settings]:



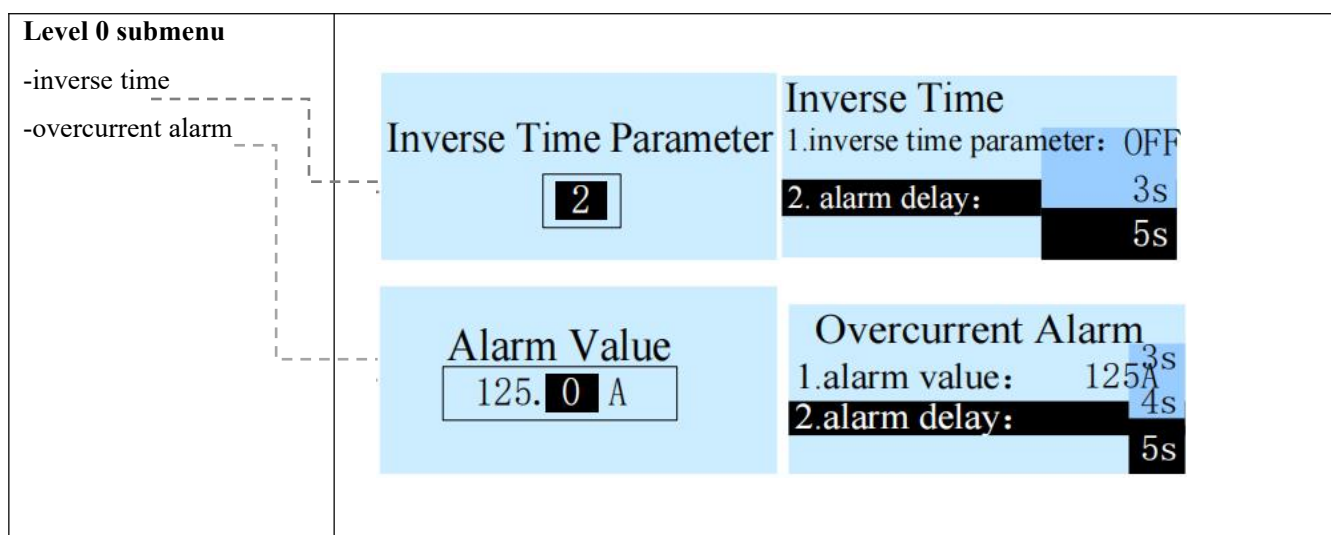

Diagram 7-9 overcurrent settings

As shown in Diagram 7-9 above, enter the **[Overcurrent Settings]** submenu:

**[Up/Down]** button to control the reverse video position or adjust the parameters.

**[Left/Right]** button to control the position of the parameter digit reverse video.

**[OK]** button to enter the corresponding settings menu/toggle setting options.

**[Return]** button to return to the previous menu.

Note:

- Inverse time: current inverse time protection is configurable.
- Over-limit alarm: overcurrent alarm function is configurable.
- Recloser: after the circuit breaker trips due to overcurrent alarm, it will automatically reclose in a short time.  
ON or OFF can be set. (Default: OFF)
- Ir1 rated value: the rated current value. Inverse time alarm and short circuit alarm are closely related to this value.
- Warning value: set the warning threshold, if the actual voltage value exceeds the set threshold, warning signal will occur.
- Alarm tripping: the function of "ON" or "OFF" to open due to the overcurrent alarm, OFF: only close the open, the alarm signal still exists. (Default: ON)
- Alarm function: the "ON" or "OFF" function of overcurrent protection configuration can be set, and the overcurrent alarm configuration will be invalid if it is turned off. (Default: ON)
- Alarm delay: overcurrent events (including inverse time overcurrent and over-limit overcurrent) will generate an overcurrent alarm if the duration exceeds this value.

- Warning function: the "ON" or "OFF" warning prompt can be set, and the overcurrent warning configuration will be invalid if it is turned off. (Default: ON)

### 7.2.4 Overload Settings

Overload settings: overload protection settings for excessive load, exceeding the rated load of the device, and the setting of warning and alarm.

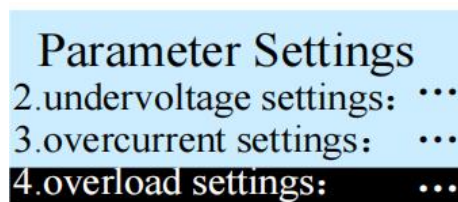

Diagram 7-10

As shown in Diagram 7-10 above, press [OK] button to enter [Overload Settings].

<b>Level menu</b> 0	<table border="1"> <tr> <td data-bbox="331 981 676 1032"> <b>Overload Settings</b> </td> <td data-bbox="676 981 1043 1032"> <b>Overload Settings</b> </td> <td data-bbox="1043 981 1401 1032"> <b>Overload Settings</b> </td> </tr> <tr> <td data-bbox="331 1032 676 1084"> <b>1.phase overload:</b> ...         </td> <td data-bbox="676 1032 1043 1084"> <b>4.phase C overload:</b> ...         </td> <td data-bbox="1043 1032 1401 1084"> <b>6.alarm trip:</b> OFF         </td> </tr> <tr> <td data-bbox="331 1084 676 1135"> <b>2.phase A overload:</b> ...         </td> <td data-bbox="676 1084 1043 1135"> <b>5.recloser:</b> OFF         </td> <td data-bbox="1043 1084 1401 1135"> <b>7.alarm:</b> OFF         </td> </tr> <tr> <td data-bbox="331 1135 676 1187"> <b>3.phase B overload:</b> ...         </td> <td data-bbox="676 1135 1043 1187"> <b>6.alarm trip:</b> OFF         </td> <td data-bbox="1043 1135 1401 1187"> <b>8.alarm delay:</b> 5.00S         </td> </tr> </table>	<b>Overload Settings</b>	<b>Overload Settings</b>	<b>Overload Settings</b>	<b>1.phase overload:</b> ...	<b>4.phase C overload:</b> ...	<b>6.alarm trip:</b> OFF	<b>2.phase A overload:</b> ...	<b>5.recloser:</b> OFF	<b>7.alarm:</b> OFF	<b>3.phase B overload:</b> ...	<b>6.alarm trip:</b> OFF	<b>8.alarm delay:</b> 5.00S
<b>Overload Settings</b>	<b>Overload Settings</b>	<b>Overload Settings</b>											
<b>1.phase overload:</b> ...	<b>4.phase C overload:</b> ...	<b>6.alarm trip:</b> OFF											
<b>2.phase A overload:</b> ...	<b>5.recloser:</b> OFF	<b>7.alarm:</b> OFF											
<b>3.phase B overload:</b> ...	<b>6.alarm trip:</b> OFF	<b>8.alarm delay:</b> 5.00S											
<b>Level menu</b> 1	<table border="1"> <tr> <td data-bbox="331 1227 676 1279"> <b>Phase Overload</b> </td> <td data-bbox="676 1227 1433 1440" rowspan="2">         Enter the [Overload Settings] level 1 submenu: [Phase Overload], [Phase A Overload], [Phase B Overload] and [Phase C Overload], and the corresponding alarm value and warning value can be set.       </td> </tr> <tr> <td data-bbox="331 1279 676 1330"> <b>1.alarm value:</b> 82.5kW         </td> </tr> <tr> <td data-bbox="331 1330 676 1382"> <b>2.warning value:</b>22.0kW         </td> <td></td> </tr> </table>	<b>Phase Overload</b>	Enter the [Overload Settings] level 1 submenu: [Phase Overload], [Phase A Overload], [Phase B Overload] and [Phase C Overload], and the corresponding alarm value and warning value can be set.	<b>1.alarm value:</b> 82.5kW	<b>2.warning value:</b> 22.0kW								
<b>Phase Overload</b>	Enter the [Overload Settings] level 1 submenu: [Phase Overload], [Phase A Overload], [Phase B Overload] and [Phase C Overload], and the corresponding alarm value and warning value can be set.												
<b>1.alarm value:</b> 82.5kW													
<b>2.warning value:</b> 22.0kW													

Diagram 7-11 overload settings

As shown in Diagram 7-11 above, enter the [Overload Settings] submenu:

[Up/Down] button to control the reverse video position or adjust the parameters.

[Left/Right] button to control the position of the parameter digit reverse video.

[OK] button to enter the corresponding settings menu/toggle setting options.

[Return] button to return to the previous menu.

Note:

- Three-phase overload: the phase load exceeds the device load; Three-phase: refers to the sum of the active power of the three phases A, B and C.

- Phase A overload: the active power of phase A load exceeds the device load.
- Phase B overload: the active power of the phase B load exceeds the device load.
- Phase C overload: the active power of the phase C load exceeds the device load.
- Alarm value: set the alarm threshold, if the actual active power value exceeds the set threshold, overload event will occur. (Default: 165V)
- Recloser: after the circuit breaker trips due to overload alarm, it will automatically reclose in a short time. ON or OFF can be set. (Default: OFF)
- Alarm tripping: the function of "ON" or "OFF" to open due to the overload alarm, OFF: only close the open, the alarm signal still exists. (Default: OFF)
- Alarm function: the "ON" or "OFF" function of overload protection configuration can be set, and the overload alarm configuration will be invalid if it is turned off. (Default: OFF)
- Alarm delay: overload event duration beyond this value will generate an overload alarm.
- Warning function: the "ON" or "OFF" warning prompt can be set, and the overload warning configuration will be invalid if it is turned off. (Default: OFF)

### 7.2.5 Over-temperature Settings

Over-temperature settings: set the over-temperature protection switch, warning and alarm.

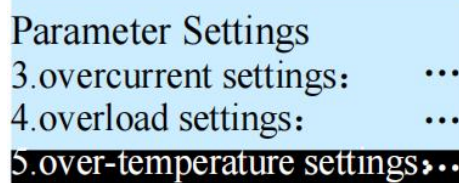

Diagram 7-12

As shown in Diagram 7-12 above, press [OK] button to enter [Over-temperature Settings].

Over-temperature Settings		Over-temperature Settings		Over-temperature Settings	
1. recloser:	OFF	4. alarm trip:	ON	5. alarm:	ON
2. alarm value:	90. 0°C	5. alarm:	ON	6. alarm delay:	10. 0S
3. warning value:	70. 0°C	6. alarm delay:	10. 0S	7. warning:	ON

Diagram 7-13 over-temperature settings

As shown in Diagram 7-13 above, enter [Over-temperature Settings]:

[Up/Down] button to control the reverse video position or adjust the parameters.

[**Left/Right**] button to control the position of the parameter digit reverse video.

[**OK**] button to enter the corresponding settings menu/toggle setting options.

[**Return**] button to return to the previous menu.

Note:

- Recloser: after the circuit breaker trips due to over-temperature alarm, it will automatically reclose in a short time. ON or OFF can be set. (Default: OFF)
- Alarm value: set the alarm threshold, if the actual temperature value exceeds the set threshold, over-temperature event will occur. (Default: 90°C)
- Warning value: set the warning threshold, if the actual temperature value exceeds the set threshold, warning signal will occur. (Default: 70°C)
- Alarm tripping: the function of "ON" or "OFF" to open due to the over-temperature alarm, OFF: only the automatic open function of the protection is turned off, the alarm prompt message still exists. (Default: ON)
- Alarm function: the "ON" or "OFF" function of over-temperature protection configuration can be set, and the over-temperature alarm configuration will be invalid if it is turned off. (Default: ON)
- Alarm delay: over-temperature event duration beyond this value will generate an over-temperature alarm. (Default: 5s)
- Warning function: the "ON" or "OFF" warning prompt can be set, and the over-temperature warning configuration will be invalid if it is turned off. (Default: ON)

### 7.2.6 Short Circuit Settings

Short circuit setting: various function settings of short circuit protection.

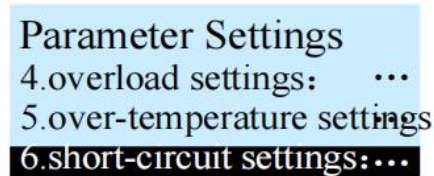

*Diagram 7-14*

As shown in Diagram 7-14 above, press [**OK**] button to enter [**Short Circuit Settings**].

Short Circuit Settings	
1.instantaneous action:	10Ir
2.delay action:	6Ir
3.delay time:	0.1S

*Diagram 7-15 short circuit settings*

As shown in Diagram7-15 above, enter [**Short Circuit Settings**]:

[**Up/Down**] button to control the reverse video position or adjust the parameters on the right.

[**Left/Right**] button to control the position of the parameter digit reverse video.

[**OK**] button to enter the corresponding settings menu/toggle setting options.

[**Return**] button to return to the previous menu.

Note:

- Instantaneous action: When the short-circuit current reaches this value, an instantaneous short-circuit open is performed.
- Delay action: when short-circuit current reaches this value, a short-circuit event occurs.
- Delay time: short circuit (short circuit current is less than the instantaneous action value, greater than the delay action value) event duration exceeds this value, which will generate a short circuit alarm and synchronously perform the short circuit open operation.

### 7.2.7 Residual Current

Residual current settings: protection setting for "the nonzero sum of the current vectors of each phase (including the neutral line) in a line", and alarm and warning setting.

Parameter Settings	
5.over-temperature settings:	...
6.short circuit settings:	...
7.residual current:	...

*Diagram 7-16*

As shown in Diagram 7-16 above, press [**OK**] button to enter [**Residual Current**].

Residual Current		Residual Current		Residual Current	
1.recloser:	OFF	4.alarm trip:	OFF	5.alarm:	ON
2.alarm value:	500mA	5.alarm:	ON	6.alarm delay:	0.50S
3.warning value:	400mA	6.alarm delay:	0.50S	7.warning:	ON

*Diagram 7-17 residual current*

As shown in Diagram7-17 above, enter **[Residual Current]**:

**[Up/Down]** button to control the reverse video position or adjust the parameters.

**[Left/Right]** button to control the position of the parameter digit reverse video.

**[OK]** button to enter the corresponding settings menu/toggle setting options.

**[Return]** button to return to the previous menu.

Note:

- Recloser: after the circuit breaker trips due to residual current, it will automatically reclose in a short time. ON or OFF can be set. (Default: OFF)
- Alarm value: set the alarm threshold, if the actual residual current value exceeds the set threshold, residual overcurrent event will occur. (Default: 500mA)
- Warning value: set the warning threshold, if the actual residual current value exceeds the set threshold, warning signal will occur. (Default: 400mA)
- Alarm tripping: the function of "ON" or "OFF" to open due to the residual current alarm, OFF: only the automatic open function of the protection is turned off, the alarm signal still exists. (Default: ON)
- Alarm function: the "ON" or "OFF" function of residual current protection configuration can be set, and the residual current alarm configuration will be invalid if it is turned off. (Default: ON)
- Alarm delay: residual overcurrent event duration beyond this value will generate an residual current alarm. (Default: 0.5s)
- Warning function: the "ON" or "OFF" warning prompt can be set, and the residual current warning configuration will be invalid if it is turned off. (Default: ON)

### 7.2.8 Voltage Phase Loss

Voltage phase loss setting: protection setting for "one phase of three-phase AC current loses power".

Parameter Settings	
6.short circuit settings:	...
7.residual current:	...
8.voltage phase loss:	...

Diagram 7-18

As shown in Diagram 7-18 above, [OK] button to enter [Voltage Phase Loss].

Voltage Phase Loss		Voltage Phase Loss	
1.recloser:	OFF	3.alarm trip:	OFF
2.alarm value:	30V	4.alarm	OFF
3.alarm trip:	OFF	5.alarm delay:	5.0S

Diagram 7-19 voltage phase loss

As shown in Diagram7-19 above, enter [Voltage Phase Loss]:

[Up/Down] button to control the reverse video position or adjust the parameters.

[Left/Right] button to control the position of the parameter digit reverse video.

[OK] button to enter the corresponding settings menu/toggle setting options.

[Return] button to return to the previous menu.

Note:

- Recloser: after the circuit breaker trips due to voltage phase loss alarm, it will automatically reclose in a short time. ON or OFF can be set. (Default: OFF)
- Alarm value: set the alarm threshold, if the actual voltage value exceeds the set threshold, voltage phase loss event will occur. (Default: 30V)
- Alarm tripping: the function of "ON" or "OFF" to open due to the alarm, OFF: only the automatic open function of the protection is turned off, the alarm signal still exists. (Default: OFF)
- Alarm function: the "ON" or "OFF" function of voltage phase loss protection configuration can be set, and the alarm configuration will be invalid if it is turned off. (Default: OFF)
- Alarm delay: voltage phase loss event duration beyond this value will generate the voltage phase loss alarm. (Default: 5s)

### 7.2.9 Current Phase Loss

Current phase loss settings: protection setting for "one phase of three-phase AC current loses power".

Parameter Settings	
7.residual current:	...
8.voltage phase loss:	...
9.current phase loss	...

Diagram 7-20

As shown in Diagram 7-20 above, press [OK] button to enter [Current Phase Loss].

Current Phase Loss		Current Phase Loss	
1.recloser:	OFF	3.alarm trip:	OFF
2.alarm value:	0.5A	4.alarm:	OFF
3.alarm trip:	OFF	5.alarm delay:	5.0S

Diagram 7-21 current phase loss

As shown in Diagram7-21 above, enter [Current Phase Loss]:

[Up/Down] button to control the reverse video position or adjust the parameters.

[Left/Right] button to control the position of the parameter digit reverse video.

[OK] button to enter the corresponding settings menu/toggle setting options.

[Return] button to return to the previous menu.

Note:

- The phase current of at least one phase is greater than 3A to trigger the current phase loss alarm.
- Recloser: after the circuit breaker trips due to current phase loss alarm, it will automatically reclose in a short time. ON or OFF can be set. (Default: OFF)
- Alarm value: set the alarm threshold, if the actual current value exceeds the set threshold, current phase loss event will occur. (Default: 0.5A)
- Alarm tripping: the function of "ON" or "OFF" to open due to the alarm, OFF: only the automatic open function of the protection is turned off, the alarm signal still exists. (Default: OFF)
- Alarm function: the "ON" or "OFF" function of current phase loss protection configuration can be set, and the current phase loss alarm configuration will be invalid if it is turned off. (Default: OFF)
- Alarm delay: current phase loss event duration beyond this value will generate the current phase loss alarm. (Default: 5s)

### 7.2.10 Unbalanced Settings

Unbalanced settings: Settings related to unbalanced protection

Parameter Settings	
9.current phase loss:	...
10.unbalance:	...
11.reverse phase sequence:	...

Diagram 7-22

As shown in Diagram 7-22 above, press [OK] button to enter [Unbalanced Settings].

Unbalance Settings		Unbalance Settings	
1. reclose:	OFF	3.alarm trip:	OFF
2.alarm value:	30%	4.alarm:	OFF
3.alarm trip:	OFF	5.alarm delay:	5. 0S

Diagram 7-23 unbalanced settings

As shown in Diagram7-23 above, enter [Unbalanced Settings]:

[Up/Down] button to control the reverse video position or adjust the parameters.

[Left/Right] button to control the position of the parameter digit reverse video.

[OK] button to enter the corresponding settings menu/toggle setting options.

[Return] button to return to the previous menu.

Note:

- Recloser: after the circuit breaker trips due to unbalanced alarm, it will automatically reclose in a short time. ON or OFF can be set. (Default: OFF)
- Alarm value: set the alarm threshold, if the unbalanced value exceeds the set threshold, unbalanced event will occur. (Default: 30%)
- Alarm tripping: the function of "ON" or "OFF" to open due to the unbalanced alarm, OFF: only the automatic open function of the protection is turned off, the alarm signal still exists. (Default: OFF)
- Alarm function: the "ON" or "OFF" function of unbalanced protection configuration can be set, and the alarm configuration will be invalid if it is turned off. (Default: OFF)
- Alarm delay: unbalanced event duration beyond this value will generate the unbalanced alarm. (Default: 5s)

### 7.2.11 Reverse Phase Sequence

Reverse sequence settings: A setting that protects when an reverse phase sequence occurs. Under normal circumstances, the phase sequence of the three-phase voltage is: phase A ahead of phase B by 120°, phase B ahead of phase C by 120° and phase C ahead of phase A by 120°, which is called the normal phase sequence. Conversely, if phase B is 120° ahead of phase A or phase C is 120° ahead of phase B or phase A is 120° ahead of phase C, this phase sequence is called reverse phase sequence. That is, the order of the reverse phase sequence is BAC, ACB or CBA.

Parameter Settings	
9.current phase loss:	...
10.unbalance:	...
11.reverse phase sequence:	..

Diagram 7-24

As shown in Diagram 7-24 above, press **[OK]** button to enter **[Reverse Phase Sequence]**.

Reverse Phase Sequence		Reverse Phase Sequence	
1.recloser:	OFF	2.alarm trip:	OFF
2.alarm trip:	OFF	3.alarm:	OFF
3.alarm:	OFF	4.alarm delay:	5. 0S

Diagram 7-25 reverse phase sequence

As shown in Diagram7-25 above, enter **[Reverse Phase Sequence]**:

**[Up/Down]** button to control the reverse video position or adjust the parameters.

**[Left/Right]** button to control the position of the parameter digit reverse video.

**[OK]** button to enter the corresponding settings menu/toggle setting options.

**[Return]** button to return to the previous menu.

Note:

- Recloser: after the circuit breaker trips due to reverse phase sequence alarm, it will automatically reclose in a short time. ON or OFF can be set. (Default: OFF)
- Alarm tripping: the function of "ON" or "OFF" to open due to the reverse phase sequence alarm, OFF: only the automatic open function of the protection is turned off, the alarm signal still exists. (Default: OFF)
- Alarm function: the "ON" or "OFF" function of abnormal phase sequence protection configuration can be set, and the reverse phase sequence alarm configuration will be invalid if it is turned off. (Default: OFF)
- Alarm delay: reverse phase sequence event duration beyond this value will generate the reverse phase

sequence alarm. (Default: 5s)

### 7.2.12 External Input Alarm

External input alarm: external alarm signal (switching value) can be accepted to generate linkage.

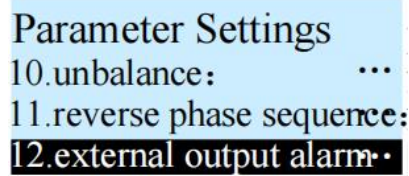

Diagram 7-26

As shown in Diagram 7-26 above, press **[OK]** button to enter **[External Input Alarm]**.

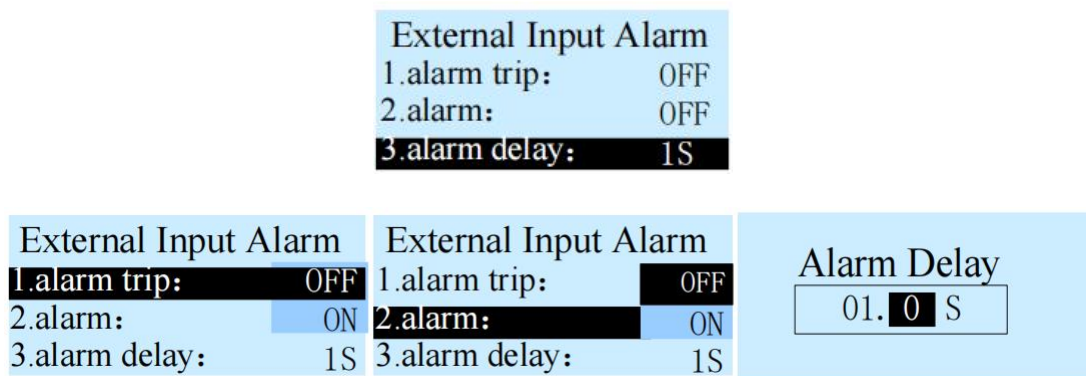

Diagram 7-27

As shown in Diagram7-27 above,

**[Up/Down]** button to control the reverse video position or adjust the parameters.

**[Left/Right]** button to control the position of the parameter digit reverse video.

**[OK]** button to enter the corresponding settings menu/toggle setting options.

**[Return]** button to return to the previous menu.

Note:

- Alarm tripping: the function of "ON" or "OFF" to open due to the abnormal external input, OFF: only the automatic open function of the protection is turned off, the alarm signal still exists. (Default: OFF)
- Alarm function: the "ON" or "OFF" function of abnormal external input protection configuration can be set, and the external input alarm configuration will be invalid if it is turned off. (Default: OFF)
- Alarm delay: abnormal external input duration beyond this value will generate the external input alarm. (Default: 1s)

### 7.2.13 Island Identification

**Island Identification:** the S3-EL residual current action circuit breaker has the ability to quickly monitor islands and immediately disconnect from the grid. Islanding judgment is mainly to detect whether the system is in an islanded status by detecting the voltage amplitude, frequency, phase and harmonic content of the inverter output terminal, that is, the common point, including over/under voltage protection, over/under frequency protection, phase mutation detection, harmonic detection, etc. The anti-islanding protection action time is not more than 3s.

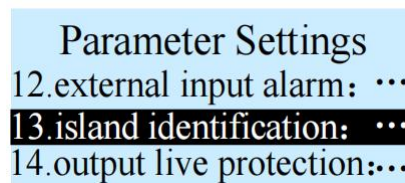

*Diagram 7-28*

As shown in Diagram 7-28 above, press **[OK]** button to enter **[Island Identification]**.

<b>Level 0 submenu</b>	<b>Island Identification</b>	<b>Island Identification</b>	<b>Island Identification</b>
	1.alarm: OFF	4.test time: 0.5S	6.frequency swing: 0.5Hz
<b>Level 1 submenu</b>	2.alarm trip: OFF	5.amplitude swing: 0.20Un	7.phase swing: 10°
	3.alarm delay: 3S	<b>6.frequency swing:0.5Hz</b>	<b>8.distortion swing: 10%</b>
	<b>Island Identification</b>	<b>Island Identification</b>	<b>Alarm Delay</b>
	1.alarm: OFF	1.alarm: OFF	0 <b>3</b> s
	2.alarm trip: ON	2.alarm trip: ON	
	3.alarm delay:	3.alarm delay:	
<b>Test Time</b>	<b>Island Identification</b>	<b>Island Identification</b>	
0. <b>5</b> s	3.alarm delay: 0.10Un	4.test time: 0.3Hz	
	4.test time: 0.15Un	5.amplitude swing:0.4Hz	
	<b>5.amplitude swing0.20Un</b>	<b>6.frequency swing:0.5Hz</b>	
<b>Island Identification</b>	<b>Island Identification</b>		
5.amplitude swing: 4°	6.frequency swing: 0.5%		
6.frequency swing: 8°	7.phase swing: 8%		
<b>7.phase swing:</b>	<b>8.distortion swing: 10%</b>		

*Diagram 7-29*

As shown in Diagram7-29 above,

**[Up/Down]** button to control the reverse video position or adjust the parameters.

**[Left/Right]** button to control the position of the parameter digit reverse video.

**[OK]** button to enter the corresponding settings menu/toggle setting options.

**[Return]** button to return to the previous menu.

Note:

- Alarm tripping: the function of "ON" or "OFF" to open due to the island status, OFF: only the automatic open function of the protection is turned off, the alarm signal still exists. (Default: OFF)
- Alarm function: the "ON" or "OFF" function of island protection configuration can be set, and the island alarm configuration will be invalid if it is turned off. (Default: OFF)
- Alarm delay: island status duration beyond this value will generate the island alarm. (Default: 1s)
- Detection time: The time to detect jitter. (Default: 0.5s)
- Amplitude swing: Irregular voltage amplitude fluctuations. (Default: 0.20Un)
- Frequency swing: Irregular voltage frequency fluctuations. (Default: 0.5Hz)
- Phase swing: Irregular voltage phase fluctuations. (Default: 10° )
- Voltage distortion: The voltage waveform no longer maintains a rational sinusoidal change.
- Distortion swing: The percentage of rms root to fundamental rms of each harmonic of the voltage. (Default: 10%)

#### 7.2.14 Output Live Protection

Output live protection: grid-connected management of new energy power generation side.

Parameter Settings	
12.external input alarm:	...
13.island identification:	...
14.output live protection:	...

*Diagram 7-30*

As shown in Diagram 7-30 above, press **[OK]** button to enter **[Output Live Protection]**.

Output Live Protection	
1.alarm:	OFF
2.prohibit close:	ON

*Diagram 7-31*

As shown in Diagram 7-31 above,

**[Up/Down]** button to control the reverse video position or adjust the parameters.

**[OK]** button to enter the corresponding settings menu/toggle setting options.

[Return] button to return to the previous menu.

Note:

Monitor the voltage at the inlet and outlet ends of the circuit breaker to meet the grid-connected management of the new energy power generation side. Close is allowed only if both of the following conditions are met:

- a) The voltage amplitude on the grid side is in the range of AC198V~AC236V.
- b) The voltage frequency on the grid side is in the range of 49.5Hz~50.5Hz.
- c) There is no output voltage on the generator side.

## 7.3 System Settings

System settings: including time settings, communication settings, display settings, password settings, feature settings, residual records, test trip settings, output functions, other settings, factory reset.

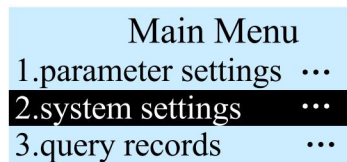

Diagram 7-32

As shown in Diagram 7-32 above, press [OK] button to enter [System Settings].

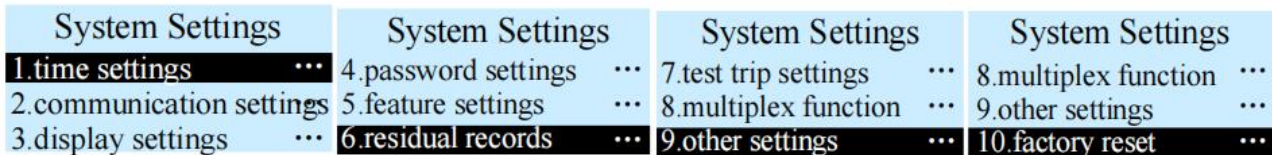

Diagram 7-33 system settings

As shown in Diagram 7-33 above, enter the [System Settings] submenu:

[Up/Down] button to control the reverse video position or adjust the parameters.

[OK] button to enter the corresponding submenu, a total of 10 submenus.

[Return] button to return to the previous menu.

### 7.3.1 Time Settings

Time Settings: Set the date and time.

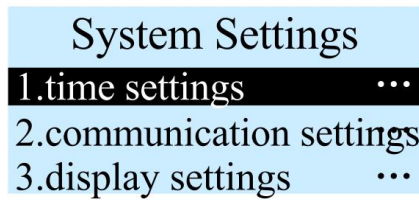

Diagram 7-34

As shown in Figure 7-34 above, press **[OK]** button to enter the **[System Settings]** submenu **[Time Settings]**.

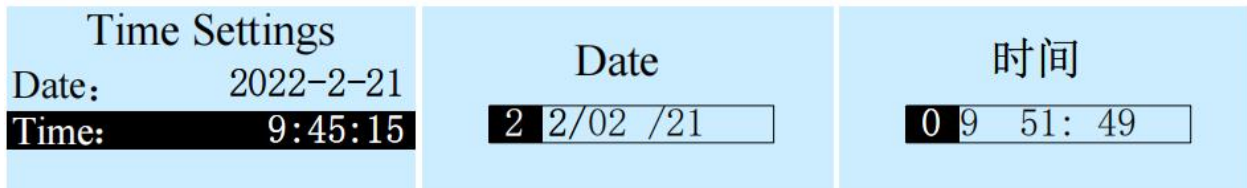

Diagram 7-35 time settings

As shown in Diagram 7-35 above, enter **[Time Settings]**:

**[Up/Down]** button to control the reverse video position or adjust the parameters.

**[Left/Right]** button to control the position of the parameter digit reverse video.

**[OK]** button to enter the corresponding option or digital adjustment parameter.

**[Return]** button to return to the previous menu.

### 7.3.2 Communication Settings

Communication settings: the external port, internal port and infrared port communication can be set.

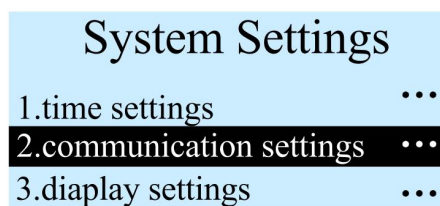

Diagram 7-36

As shown in Diagram 7-36 above, press **[OK]** button to enter the **[System Settings]** submenu **[Communication Settings]**.

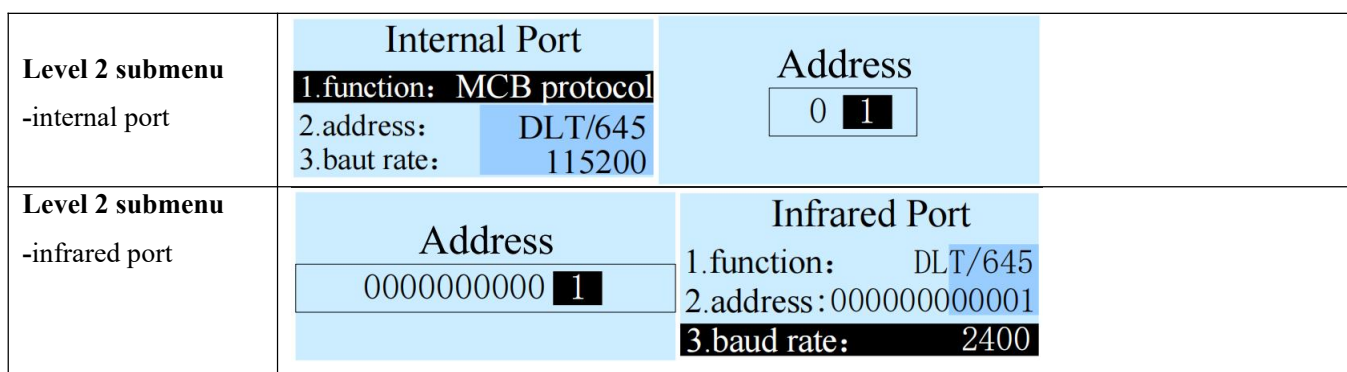
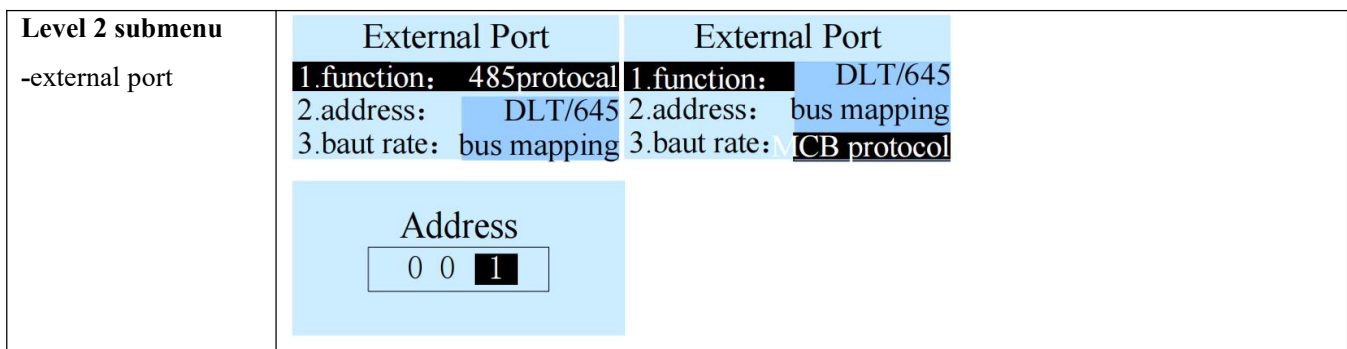
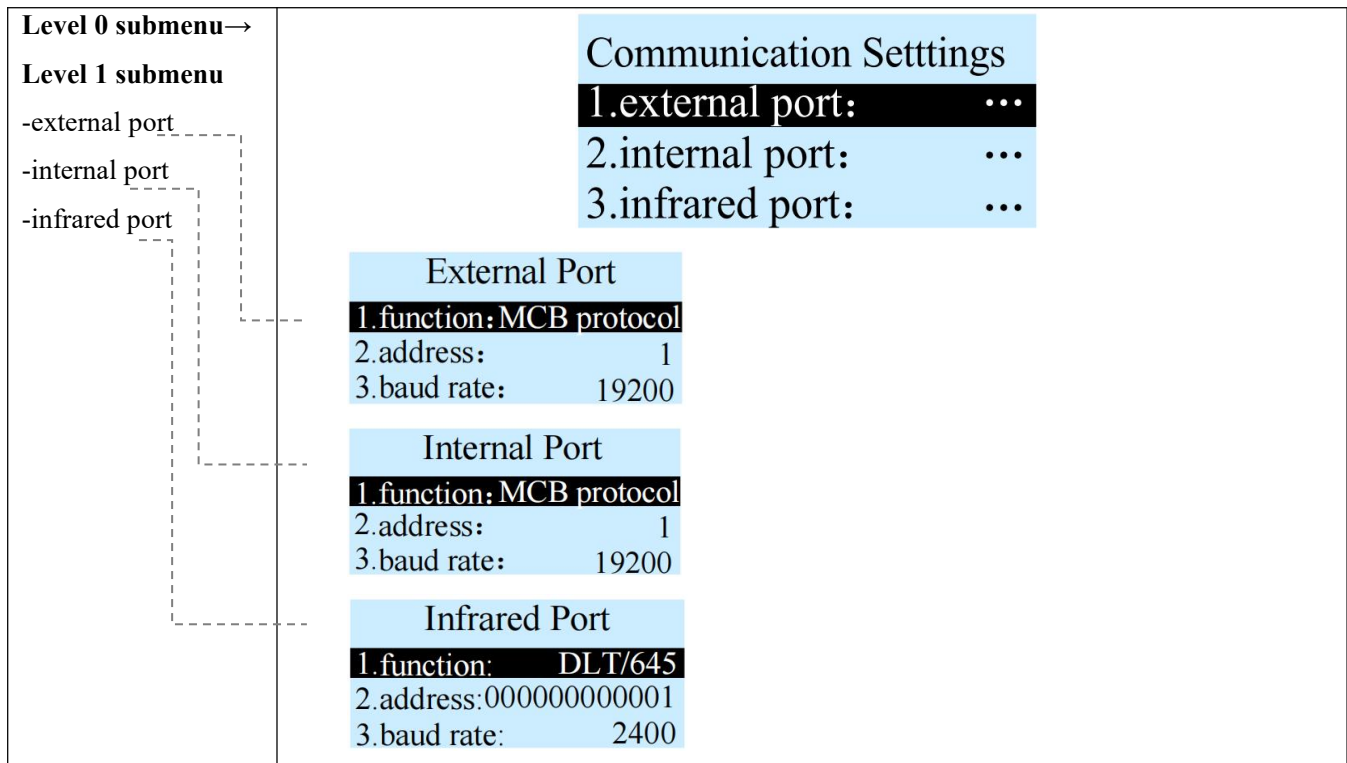

Diagram 7-37 communication settings

As shown in Diagram 7-37 above, enter [**Communication Settings**]:

- [**Up/Down**] button to control the reverse video position or adjust the parameters.
- [**Left/Right**] button to control the position of the parameter digit reverse video.
- [**OK**] button to enter the corresponding option or digital adjustment parameter.
- [**Return**] button to return to the previous menu.

**Notes:**

- Baud rate: specifies the communication rate.
- Check bit: no check, odd check, and even check for option.
- Stop bit: 1 or 2 stop bits for option.

### 7.3.3 Display Settings

Display settings: the objects and time displayed on the scrolling screen, automatic return time, and display contrast can be set.

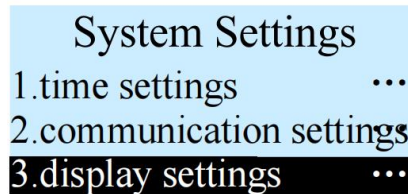

Diagram 7-38

As shown in Diagram 7-38 above, press [OK] button to enter the [System Settings] submenu [Display Settings].

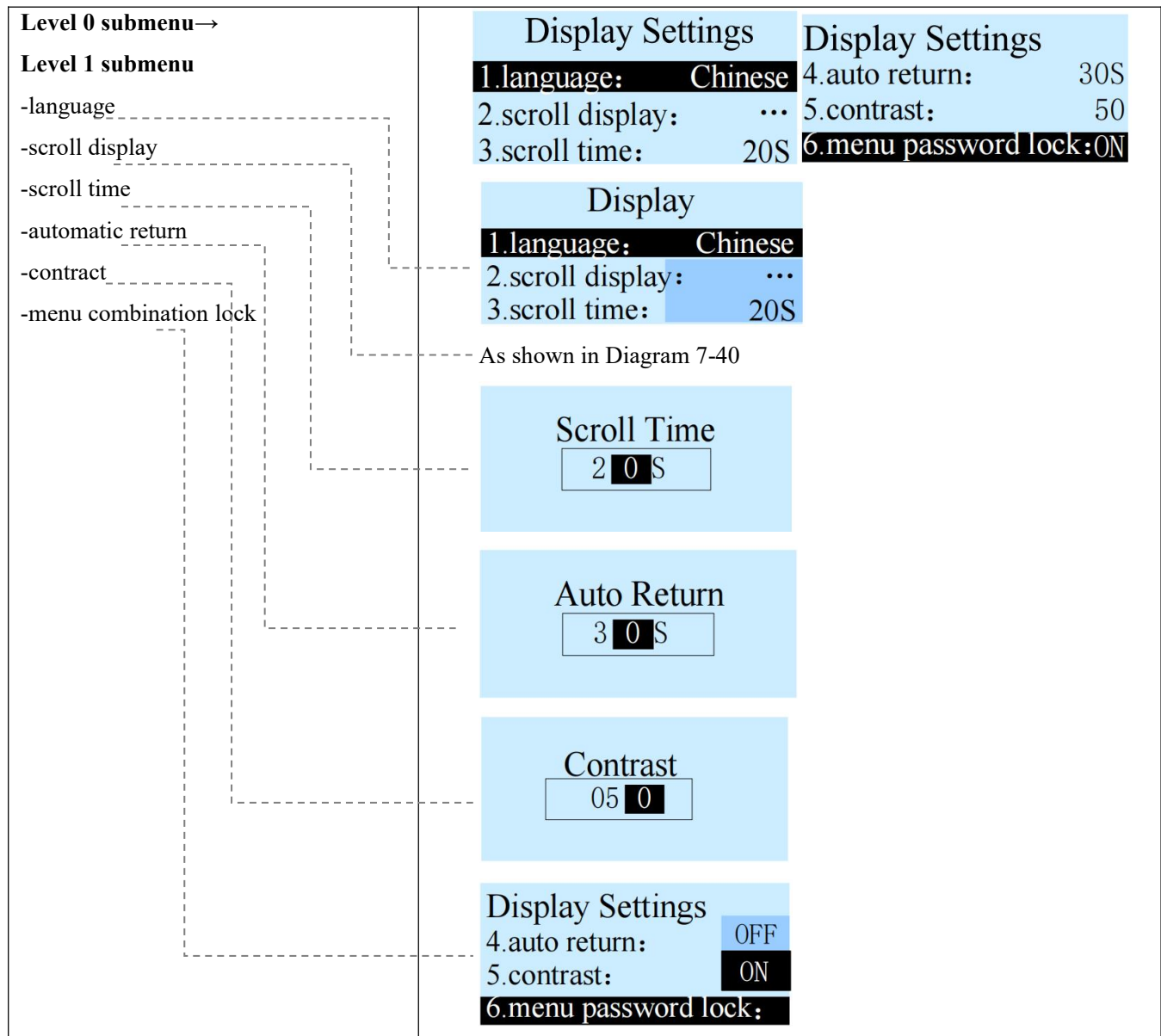

Diagram 7-39 level 1 submenu of display Settings

**Scroll display the submenus:**

Scroll Display		Scroll Display		Scroll Display	
1.input voltage:	ON	4.reactive power:	ON	7.reactive power:	ON
2.output current:	ON	5.apparent power:	ON	8.power factor:	ON
3.active power:	ON	6.active energy:	...	9.line temperature:	ON

Scroll Display		Scroll Display	
10.residual current:	ON	11.current waveform:	ON
11.current waveform:	ON	12.voltage waveform:	ON
12.voltage waveform:	ON	13.unbalance:	ON

**Scroll display → submenus with active energy:**

Active Energy		Active Energy		Active Energy	
1.total energy:	ON	4.T3 shoulder energy:	ON	6.T5 energy:	ON
2.T1 sharp energy:	ON	5.T4 off-peak energy:	ON	7.T6 energy:	ON
3.T2 peak energy:	ON	6.T5 energy:	ON	8.T7 energy:	ON

*Diagram 7-40 scroll display*

As shown in Diagram 7-39 and 7-40 above, enter **[Display Settings]**, **[Scroll Display]**:

**[Up/Down]** button to control the reverse video position or adjust the parameters.

**[Left/Right]** button to control the position of the parameter digit reverse video.

**[OK]** button to enter the corresponding option or digital adjustment parameter.

**[Return]** button to return to the previous menu.

**Note:**

- Language: English and Chinese are optional.
- Scroll display: it can be chosen to turn on or off whether the input voltage, output current, active power, reactive power, apparent power, functional quantity, power factor, residual current, and unbalance are scrolled on the screen.
- Scroll time: the data scrolls to show the interval in turn.
- Automatic return: non-data scroll display interface, no operation time to reach the setting value, automatic return scrolling. Except in exceptional circumstances.
- Contrast: Adjusts the display contrast value.
- The active energy sub-menu includes: total power, T1 tip energy, T2 peak energy, T3 flat energy, T4 valley

energy, T5 energy, T6 energy, T7 energy, and its display can be set "ON" or "OFF". (The default is: "ON")

### 7.3.4 Password Settings

Password settings: Level 0 password, level 1 password, and level 2 password.

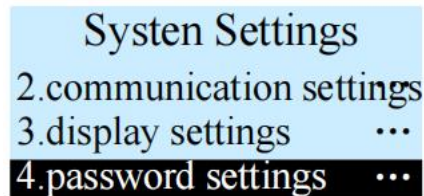

Diagram 7-41

As shown in Diagram 7-41 above, press **[OK]** button to enter the **[System Settings]** submenu **[Password Settings]**.

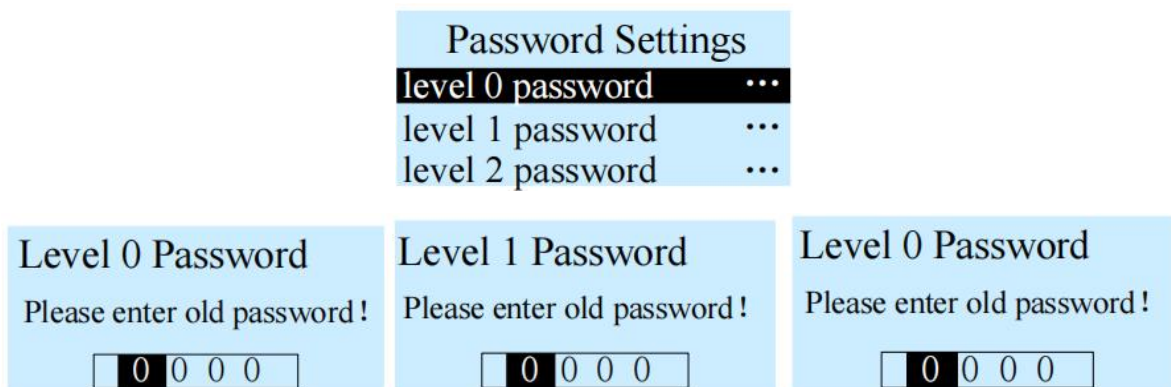

Diagram 7-42 password settings

As shown in Diagram 7-42 above, enter **[Password Settings]**:

**[Up/Down]** button to control the reverse video position.

**[Left/Right]** button to control the position of the parameter digit reverse video.

**[OK]** button to enter the corresponding option or digital adjustment parameter.

**[Return]** button to return to the previous menu.

### 7.3.5 Feature Settings

Feature Settings: Feature function settings. It can open or close the total alarm, total warning, alarm sound, alarm flash, and total reclosing functions; it can set the parameters for the number of reclosers, recloser delay, and recloser reset.

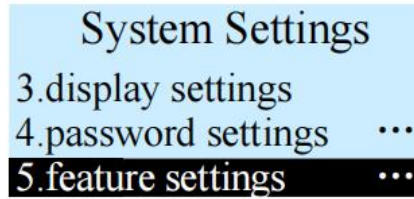

*Diagram 7-43*

As shown in Diagram 7-43 above, press **[OK]** button to enter **[System Settings]** submenu **[Feature Settings]**.

Feature Settings		Feature Settings		Feature Settings	
<b>1. total alarm:</b>	ON	4. alarm flash:	OFF	6. number of reclosers:	1
2. total warning:	ON	5. total recloser:	ON	7. recloser delay:	60S
3. alarm sound:	OFF	<b>6. number of reclosers:</b>	<b>1</b>	<b>8. recloser reset:</b>	<b>60S</b>

*Diagram 7-44 feature settings*

As shown in Diagram 7-44 above, enter **[Feature Settings]**:

**[Up/Down]** button to control the reverse video position.

**[Left/Right]** button to control the position of the parameter digit reverse video.

**[OK]** button to enter the corresponding option or digital adjustment parameter.

**[Return]** button to return to the previous menu.

**Note:**

- Total alarm: cannot be set temporarily, it is enabled by default.
- Total warning: the warning configuration in the "on" or "off" parameter settings can be set, and the warning will be invalid if it is turned off. (Default: ON)
- Alarm sound: "ON" or "OFF" of the buzzer alarm reminder can be set. (Default: ON)
- Alarm flash: "ON" or "OFF" can be set to flash the backlight when a new alarm is generated. (Default: ON)
- Total recloser: "ON" or "OFF" can be set. If it is turned off, all recloser configurations in the parameter configuration are invalid. (Default: ON)
- Number of reclosers: the number of reclosers in the parameter configuration is configurable. (Default: 1)
- Recloser delay: configuration the delay time of reclosing in the configuration parameter. (Default: 60s)
- Recloser reset: after successful recloser, if the time is less than the reset time, it will try to reclose again until the number of reclosers is exhausted. (Default: 60s)

### 7.3.6 Residual Records

Residual Records: configure the residual current records conditions.

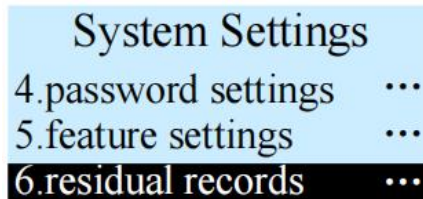

*Diagram 7-45*

As shown in Diagram 7-45 above, press **[OK]** button to enter the **[System Settings]** submenu **[Residual Records]**.

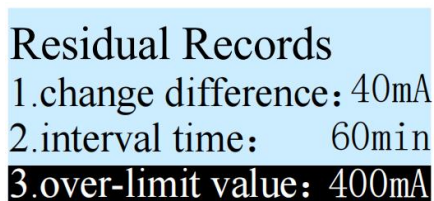

*Diagram 7-46 residual records*

As shown in Diagram 7-46 above, enter **[Residual Records]**:

**[Up/Down/Left/Right]** button to control the reverse video position or adjust parameters.

**[OK]** button to enter the corresponding option or digital adjustment parameter.

**[Return]** button to return to the previous menu.

Note:

- **Change difference:** set a threshold, when the residual current exceeds this threshold, an event record will be triggered, which can be viewed by querying the log. (Default: 40mA)
- **Interval time:** Set a time, trigger an event record every time the set time interval passes, which can be viewed by querying the log.
- **Over-limit value:** Set a threshold, when the residual current exceeds this threshold, an event will be triggered, and the recording will be ended when the residual current is lower than the setting value, which can be viewed by querying the log. (Default: 400mA)

### 7.3.7 Test Trip Settings

Test trip settings: test the trip function.

System Settings	
5.feature settings	...
6.residual records	...
<b>7.test trip settings</b>	...

*Diagram 7-47*

As shown in Diagram 7-47 above, press **[OK]** button to enter the **[System Settings]** submenu **[Test Trip Settings]**.

Test Trip Settings	
<b>test trip:</b>	<b>OFF</b>
time:	1st 00:00
auto close:	OFF

*Diagram 7-48 test trip settings*

As shown in Diagram 7-48 above, enter **[Residual Records]**:

**[Up/Down/Left/Right]** button to control the reverse video position or adjust parameters.

**[OK]** button to enter the corresponding option or digital adjustment parameter.

**[Return]** button to return to the previous menu.

Note:

- Test trip function: the “on” or “off” of test trip detection can be set. (Default: OFF)
- Time: a specific time on any day of the month for test trip detection can be set. It is recommended to be less than or equal to the 28th, otherwise some months will not be able to perform actions (For example, in non-leap years, February has only 28 days, and if it is set to 29, the trip will not be attempted in February).
- Automatic close: after the test trip detection, “OFF”, “5 seconds”, “10 seconds”, “15 seconds” to re-close are optional.

### 7.3.8 Multiplex Function

System Settings	
6.residual records	...
7.test trip settings	...
<b>8.multiplex function</b>	...

*Diagram 7-49*

As shown in Diagram 7-49 above, press **[OK]** button to enter the **[System Settings]** submenu **[Output Function]**.

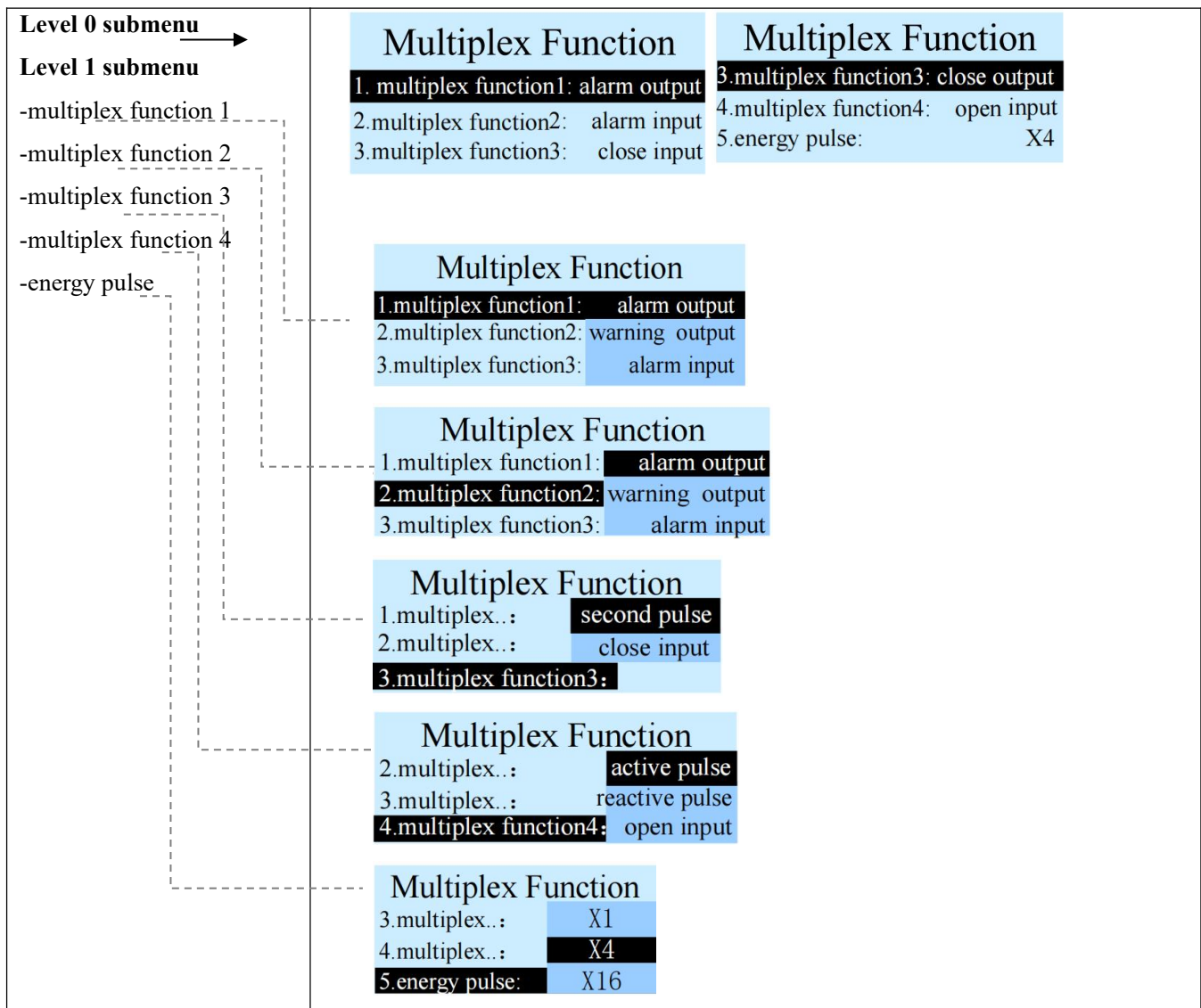

Diagram 7-50 output function

As shown in Diagram 7-50 above, enter **[Multiplex Function]**:

**[Up/Down]** button to control the reverse video position.

**[OK]** button to enter the corresponding option or digital adjustment parameter.

**[Return]** button to return to the previous menu.

Note:

- Pulse per second: A time-based signal with one pulse per second.
- Active pulse: output active pulse according to the standard of the electric meter, which is used to detect the accuracy of measurement.
- Reactive pulse: output reactive pulse according to the standard of the electric meter, which is used to detect

the accuracy of measurement. (internal reservation function)

- Energy pulse: output electric energy pulse according to the standard of the electric meter, which is used to detect the accuracy of measurement. (Do not modify the default X4)
- Alarm output: synchronously output alarm signals to other devices.
- Warning output: synchronously output warning signals to other devices.
- Alarm input: support external switching value alarm input.
- Closing input: support external switching value close input.
- Open input: support external switching value open input.

### 7.3.9 Other Settings

System Settings	
7.test trip settings	...
8.multiplex settings	...
9.other settings	...

Diagram 7-51

As shown in Diagram 7-51 above, press **[OK]** button to enter the **[System Settings]** submenu **[Other Settings]**.

Other Settings		Other Settings	
1.power-on test:	OFF	3.power-off trip:	OFF
2.power-on trip:	OFF	4.close input:	OFF
3.power-off trip:	OFF	5.open input:	OFF

Diagram 7-52 other settings

As shown in Diagram 7-52 above, enter **[Other Settings]**:

**[Up/Down]** button to control the reverse video position.

**[OK]** button to enter the corresponding option or digital adjustment parameter.

**[Return]** button to return to the previous menu.

Note:

- Power-on test: It can be set to “ON” or “OFF”. (Default: OFF)
- Power-off trip: “1s/2s/3s/4s/5s/6s/7s/8s/9s/10s/off” can be set, and the device will automatically open after the mains power failure. (Default: OFF)
- Power-on trip: “ON” or “OFF” can be set, the device will automatically open after power-on. (Default: OFF)

- Close input: It can be set to “ON” or “OFF”, which can be used for linkage through external IO control device close. (Default: OFF)
- Open input: It can be set to “ON” or “OFF”, which can be used for linkage through external IO control device close. (Default: OFF)

### 7.3.10 Factory Reset

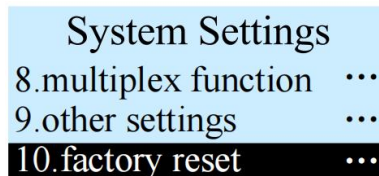

*Diagram 7-53*

As shown in Diagram 7-53 above, press [OK] button to enter [System Settings] submenu [Factory Reset].

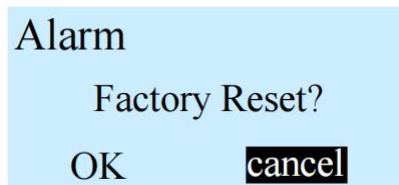

*Diagram 7-54 factory reset*

As shown in Diagram 7-54 above, enter [Factory Reset]:

[Left/Right] button to control the reverse video position.

[OK] button to confirm the corresponding option.

[Return] button to return to the previous menu.

**Note:** After the factory reset, the configuration in the parameter settings will all be restored to the default status of the initialization value.

## 7.4 Query Records

Query records: the cumulative records, peak records, residual overrun records, self-test records, trip records, close records, residual alarm records, line alarm records, line residual records, and system records can be queried.

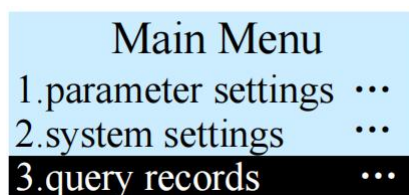

*Diagram 7-55*

As shown in Diagram 7-55 above, press **[OK]** button the main menu to enter **[Query Records]**.

Query Records		Query Records	
1.culmulative records ...	2.peak records ...	4.self-test records ...	5.trip records ...
3.residual overrun records	6.close records ...	7.residual alarm records ...	8.line alarm records ...
8.line alarm records ...	9.line residual records ...	9.line residual records ...	10.system records ...

*Diagram 7-56 query records*

As shown in Diagram 7-56 above, enter **[Query Record]**:

**[Up/Down]** button to control the reverse video position.

**[OK]** button to enter the corresponding submenu.

**[Return]** button to return to the previous menu.

#### 7.4.1 Cumulative Records

Cumulative record: cumulative number of data clearing, abnormal trips and running time.

Query Records	
1.culmulative records ...	2.peak records ...
3.residual overrun records	

*Diagram 7-57*

As shown in Diagram 7-57 above, press **[OK]** button to enter the **[Query Records]** submenu **[Cumulative Record]**.

data clear:	0 times	current trip:	0 times
fault trip:	0 times	voltage trip:	0 times
lock trip:	0 times	manual trip:	0 times
residual trip:	0 times	remote trip:	0 times
serial port trip:	0 times	operation:	41 min
netural loss:	0 times		
test trip:	0 times		
return residual:	0 times		

Diagram 7-58 cumulative records

As shown in Diagram 7-58 above, enter **[Cumulative Record]**:

**[Up/Down]** button to page up and down.

**[Return]** button to return to the previous menu.

Note:

- Fault trip: the number of trips due to power fault.
- Lock trip: abnormal alarm or other reasons for close and lock are not allowed to close.
- Residual trip: the number of trips caused by abnormal residual current.
- Current trip: the number of trips caused by abnormal current.
- Serial port trip: the number of trips caused by external serial port communication operations.
- Test Trip: the number of trips caused by the test trip function.
- Manual Trip: the number of trips caused by the manual emergency TIP button.
- Remote trip: the number of trips caused by controlling the open signal through remote APP, etc.

#### 7.4.2 Peak Records

Peak record: The peak record of each subdivision electrical parameter.

Query Records	
1.culmulative records	...
2.peak records	...
3.residual overrun records	

Diagram 7-59

As shown in Diagram 7-59 above, press **[OK]** button to enter **[Query Records]** submenu **[Peak Records]**.

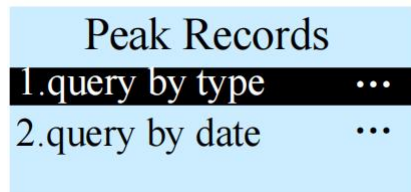

*Diagram 7-60 peak records*

As shown in Diagram 7-60 above, enter **[Peak Records]**:

**[Up/Down]** button to control the reverse video position.

**[OK]** button to enter the corresponding submenu.

**[Return]** button to return to the previous menu.

Note:

If you press the **[OK]** button to enter [Query by Type], you can query: 1. A-phase voltage peak value, 2. B-phase voltage peak value, 3. C-phase voltage peak value, 4. A-phase current peak value, 5. B-phase current peak value, 6. C-phase current peak value, 7. N-phase current peak value, 8.A-phase peak power value, 9.B-phase peak power value, 10.C-phase peak power value, 11. Total power peak value, 12. A-phase temperature peak value, 13.B-phase temperature peak value, 14. C-phase temperature peak value, 15. N-phase temperature peak value, 16. Residual current peak value; press the **[OK]** button again to enter one of the above options to view the specific record.

If you press the **[OK]** button to enter [Query by Date], you can query: 1st peak record to 31st peak record; press the **[OK]** button again, you can enter one of the above options to view the specific record.

#### 7.4.3 Residual Overrun Records

Residual overrun records: the record of the residual current exceeding the limit.

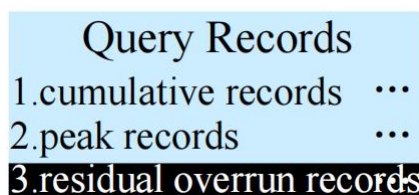

*Diagram 7-61*

As shown in Diagram 7-61 above, press the **[OK]** button to enter the **[Query Records]** submenu **[Residual Overrun Records]**:

Press the **[OK]** button again to view the specific records.

Self-test records, trip records, close records, residual alarm records, line alarm records, line residual records, and system records are viewed in the same way as the residual overrun records.

## 7.5 Operation and Maintenance

Operation and maintenance: test trip, system self-test, mechanical test, password reset, logout and return can be viewed and set.

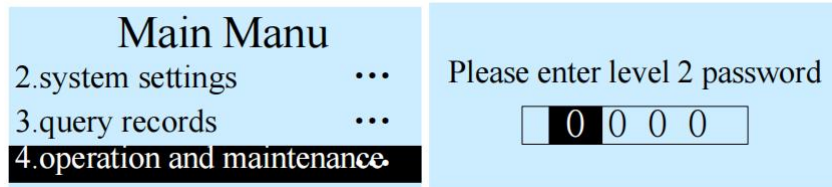

Diagram 7-62

As shown in Diagram 7-62 above, enter the level 2 password to log in and enter **[Operation and Maintenance]**.

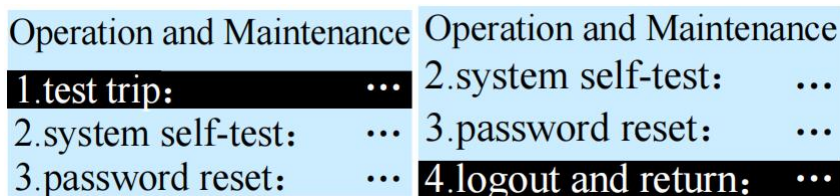

Diagram 7-63 operation and maintenance

As shown in Diagram 7-63 above, enter **[Operation and Maintenance]**:

**[Up/Down]** button to control the reverse video position.

**[OK]** button to enter the corresponding submenu/toggle setting options.

**[Return]** button to return to the previous menu.

**Note:**

- The operation and maintenance menu requires a level 2 password to log in. After logging in for a long time without keyboard operation, it will automatically log out.
- Under the operation and maintenance menu, you can view and operate the event record, login password, switch status, etc.
- Test trip: if the switch is in the close status, the test trip function will be activated to check whether it can trip normally.
- System self-test: start the self-test program to check for errors.

### 7.5.1 Test Trip

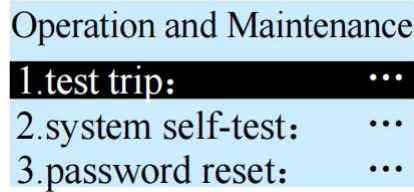

*Diagram 7-64*

As shown in Diagram 7-64 above, press the **[OK]** button to enter **[Operation and Maintenance]** submenu **[Test Trip]**.

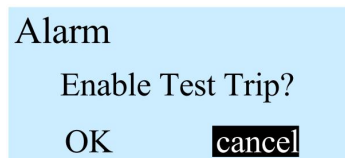

*Diagram 7-65 test trip*

As shown in Diagram 7-65 above, enter **[Test Trip]**:

**[Left/Right]** button to control the reverse video position.

**[OK]** button to select setting options.

**[Return]** button to return to the previous menu.

### 7.5.2 System Self-test

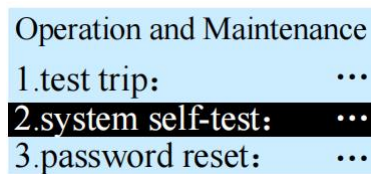

*Diagram 7-66*

As shown in Diagram 7-66 above, press the **[OK]** button to enter the **[Operation and Maintenance]** submenu **[System Self-test]**:

Press the **[OK]** button again to perform the self-test operation.

**[Return]** button to return to the previous menu.

### 7.5.3 Password Reset

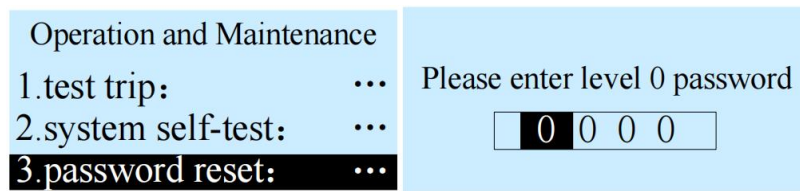

*Diagram 7-67*

As shown in Diagram 7-67 above, press the **[OK]** button to enter the **[Password Reset]** password input interface:

**[Left/Right]** button to control the reverse video position.

**[Up/Down]** button to adjust the number of the current reverse video.

Press the **[OK]** button again to confirm the password.

**[Return]** button to return to the previous menu.

**Note:** level 0 password is needed to reset the password and it will automatically return to the maintenance menu when the password is correct.

### 7.5.4 Logout and Return

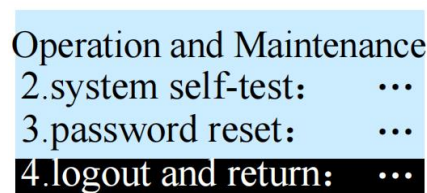

*Diagram 7-68*

As shown in Diagram 7-68 above, press the **[OK]** button to enter the **[Operation and Maintenance]** submenu

**[Logout and Return]:**

Press the **[OK]** button again to enter the operation.

**[Return]** button to return to the previous menu.

**Note:** After logging out and returning, a password is needed to enter again.

## 7.6 Energy Analysis

Energy analysis: real-time monitoring and unified management analysis of energy quality indicators, divided into real-time waveform and harmonic analysis.

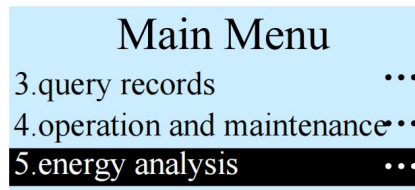

*Diagram 7-69*

As shown in Diagram 7-69 above, press the **[OK]** button to enter **[Energy Analysis]**.

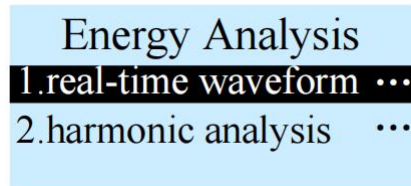

*Diagram 7-70 energy analysis*

As shown in Diagram 7-70 above, enter **[Energy Analysis]** submenu:

**[Up/Down]** button to control the reverse video position.

**[OK]** button to enter the corresponding submenu/toggle setting options.

**[Return]** button to return to the previous menu.

### 7.6.1 Real-time Waveform

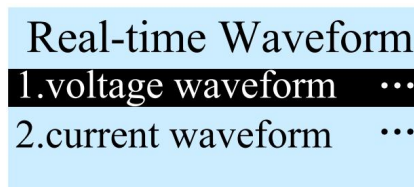

*Diagram 7-71 real-time waveform*

As shown in Diagram 7-71 above, enter the **[Real-time Waveform]** submenu **[Voltage Waveform]** or **[Current Waveform]** after pressing the **[OK]** button, and press the **[OK]** button again to view the corresponding waveform.

### 7.6.2 Harmonic Analysis

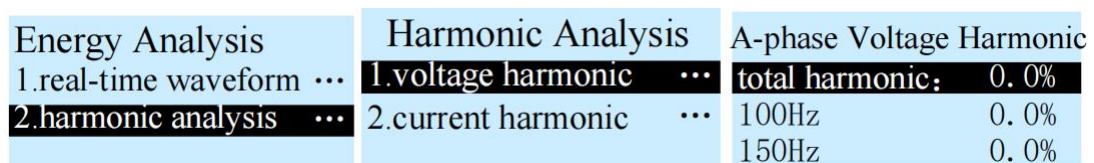
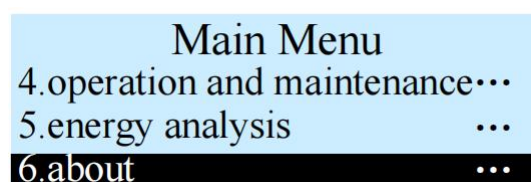

*Diagram 7-72 harmonic analysis*

As shown in Diagram 7-72 above, enter **[Harmonic Analysis]** after pressing the **[OK]** button, **[Voltage Harmonic]** or **[Current Harmonic]** can be selected for harmonic analysis, and press the **[OK]** button again to view specific data. Press the **[Return]** button to return to the previous menu.

## 7.7 About

About: device version information and service information can be viewed.



*Diagram 7-73*

As shown in Diagram 7-73 above, press the **[OK]** button to enter **[About]**.

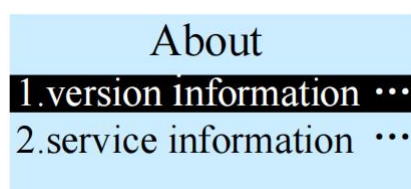

*Diagram 7-74 about*

As shown in Diagram 7-74 above, enter **[About]** interface:

**[Up/Down]** button to control the reverse video position or adjust parameters.

**[OK]** button to view the specific information of the options.

**[Return]** button to return to the previous menu.

## 8 Photovoltaic Application Configuration

### 8.1 Recommended Configuration for Photovoltaic

Table 8-1: Recommended Configuration

Items	Configuration	Menu Position
<b>Output Live Protection</b>	Alarm function: ON No close: ON <b>Note:</b> Turn on the output live protection (when the output is live, the close operation is prohibited)	[Set] key → Main menu → Parameter settings → Output live protection (see 7.2.14 for details)
<b>Test Power On</b>	ON	[Set] key → Main menu → System

Items	Configuration	Menu Position
	<b>Note:</b> Turn on the power-on automatic close function. Only one attempt can be made, if there is any abnormality when close, it must be done manually/remotely to realize the close of the device	settings → Other settings → Power on (see 7.3.9 for details)
<b>Power-off Trip</b>	ON <b>Note:</b> Turn on the automatic trip function in power failure	[Set] key → Main menu → System settings → Other settings → Power-off trip (see 7.3.9 for details)
<b>Power-on Trip</b>	OFF <b>Note:</b> Turn off the power-on trip function	[Set] key → Main menu → System settings → Other settings → Power-on trip (see 7.3.9 for details)
<b>Island Protection</b>	Alarm function: ON Alarm trip: ON Alarm delay: 5s Detection time: 1s (no configuration required without this menu) Amplitude swing: OFF (recommended), optionally configurable to 0.2Un Frequency swing: 0.5Hz Phase swing: 10° Distortion swing: 10% <b>Note:</b> When the trip is not required, the alarm trip can be configured to OFF	[Set] key → Main menu → Parameter settings → Island identification (see 7.2.13 for details)

## 8.2 Precautions for Photovoltaic Protection Function

### 8.2.1 About Island Detection

- 1) When the product leaves the factory and is restored to the factory, the island detection alarm function and alarm trip are off by default, and all parameters must be set according to the application before the product can be put into operation.
- 2) When the EL series smart moulded case performs passive island detection, due to the complexity of field applications, the detection results cannot be guaranteed to be absolutely reliable. For application scenarios that may endanger personal and property safety once an abnormality is detected, functions related to island detection cannot be used. When there are false positives or false negatives, it is necessary to adjust the detection parameters and turn on or off the testing items according to the site conditions.

### 8.2.2 About Power-on Test

There may be failures in the power-on test, for example: there is an open alarm fault (leakage, over-voltage, over-

temperature, output live, etc.) during automatic power-on. When the power-on test fails to close, the moulded case will not try to close again.

### 8.2.3 Prohibit Manual Closing When Power Off

When the photovoltaic application is powered off, the open action is automatically performed (the power-off tripping function is turned on). Do not manually close the switch when the power is off, otherwise it will be output immediately when the power is turned on (the moulded case is currently in the close status).

## 9 Installation and Wiring

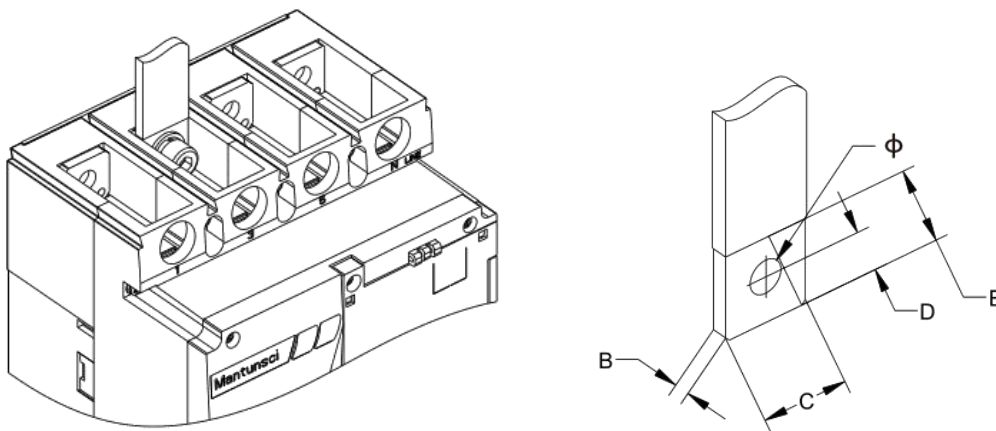

Diagram 8-1 busbar or lug

Table 8-1: Busbar or Lug Size

Busbar or Lug Size					
Size (mm)	$\phi$	B	C	D	E
S3-EL125S	8.5	$\leq 8$	$\leq 17.5$	$\leq 7$	$\geq 16$
S3-EL250S	8.5	$\leq 10$	$\leq 22$	$\leq 11.8$	$\geq 22$
S3-EL400S	10.5	$\leq 10$	$\leq 30$	$\leq 12.8$	$\geq 29$
S3-EL630S	10.5	$\leq 12$	$\leq 30$	$\leq 12.8$	$\geq 29$

Table 8-2: Terminal Blocks/Mounting Screw Tightening Torque

Terminal Blocks/Mounting Screw Tightening Torque		
Frame Rated Current(A)	Thread Diameter (mm)	Torque (N.m)
125	M8	12

<b>250</b>	M8	12
<b>400</b>	M10	20
<b>630</b>	M10	28

Note: The standard agreed wiring method and the agreed torque should be used for on-site installation.

## 10 The Cross-sectional Area of the Connecting Wire and the Rated Current of the Trip Unit

### 10.1 The Rated Current is not More Than 400A

Table 9-1:

The Rated Current is not More Than 400A													
<b>Rated Current A</b>	16、 20	25	32	40、 50	63	80	100	125、 140	160	180、 200、 225	250	315、 350	400
<b>Cross-sectional Area of the Connecting Wire mm<sup>2</sup></b>	2.5	4.0	6.0	10	16	25	35	50	70	95	120	185	240

### 10.2 The Rated Current is More Than 400A

Table 9-2:

Rated Current A	Cable		Copper Bar	
	Cross-sectional Area mm <sup>2</sup>	Amount	Size mm×mm	Amount
500	150	2	30×5	2
630	185	2	30×6	2

## 11 Transportation and Storage

### 11.1 Transportation

- During the transportation of the product, it should prevent the invasion and mixing of water, rain, snow or other chemical solvents, corrosive liquids and other harmful liquids.
- Prevents strong collision and crushing between objects.
- According to the direction of the packaging, the number of layers is shown in the outer box of the package.

### 11.2 Storage

- Storage environment conditions: temperature  $-40\text{ }^{\circ}\text{C} \sim +75\text{ }^{\circ}\text{C}$ .
- Relative humidity  $\leq 95\%$  (non-condensing).
- The storage place should be free of dust and conductive dust.
- No corrosive, flammable and explosive gases, no rain and snow.
- Dry and well ventilated.
- Stack according to the direction of the packaging instructions, stacking no higher than 4 layers.

## 12 Maintenance Precautions

- Do not disassemble the unit without authorization.
- Do not place the unit near a magnetic field.
- Avoid using this machine in high temperature, low temperature or high humidity environment, specific temperature and humidity requirements refer to the equipment parameter table.
- During the use or maintenance of this machine, the electrical safety regulations of the country and the use area must be strictly observed.
- In the wiring, disassembly and other operations must be disconnected from the input power supply of the electric box, and do not operate with power on.
- Do not disassemble or assemble with power on, or forcibly pry the 6PIN pin of the data interface to avoid damage to the data interface or abnormal communication.
- When disassembling the device, the guide rail card must be pulled down first to avoid the guide rail card

being damaged due to forcible removal.

- Please use the power module provided by the original factory.
- Avoid installing the unit in direct sunlight, poorly ventilated locations, or near heat sources such as heaters or radiators (ignoring this may result in a drop in the breaking protection performance of the product or abnormal alarms and breaks).
- When cleaning the outer surface of the device, please disconnect the input power of the electric box, and do not operate with power on. Use a soft dry cloth or other substitutes to wipe the outer surface, do not use liquid detergents to wash, to avoid short circuit caused by water immersion or moisture.
- If the supporting device of this machine is not running normally, please contact the dealer or customer service center where you purchased the device in time and provide the fault scene and status records. (The company does not assume any responsibility for problems caused by unapproved modifications or repairs).
- Please understand that the device may face network security problems when accessing the Internet, please strengthen the protection of personal information and data security. When you find that the device may have network security risks, please contact us in time.
- Please be sure to reasonably configure and properly keep all device codes, passwords, device configuration information and other related product security settings.
- After the machine is put into normal operation, the test should be carried out once a month, and the test record should be made.

## 13 Statement

- This manual is designed according to the use of Matis Electric series products. Without the consent of Matis Co., Ltd., any company or individual may not copy and backup this manual in any form (electronic, mechanical, photocopying, recording or other forms).
- It is recommended to use this manual under the guidance of professionals.
- This manual only provides the operation method of Matis Electric products, and the company does not assume any responsibility for the various consequences caused by using the operation method for the operation of other device. For the non-quality problems caused by improper installation and use and the burning of terminals due to improper wiring, the company does not assume the "three guarantees" responsibility.

- To the fullest extent permitted by law, this manual and the product described (including its hardware, software, firmware, etc.) are provided "as is" and may be subject to defects or errors. Matis Electric does not provide any form of express or implied warranties, including but not limited to warranties of merchantability, quality satisfaction, fitness for a particular purpose, etc.; nor will it make any compensation for any special, incidental, incidental or indirect damages caused by the use of this manual or the use of Matis Electric products, including but not limited to loss of business profits, system failure, loss of data or documents.
- When using this product, please strictly abide by applicable laws and regulations to avoid infringement of third party rights, including but not limited to publicity rights, intellectual property, data rights or other privacy rights. You also may not use this product for weapons of mass destruction, chemical and biological weapons, nuclear explosions or any unsafe use of nuclear energy or human rights violations.
- In the event of a conflict between the contents of this manual and applicable law, the law shall prevail.
- Our company has always strived for perfection and continuously improved product performance. Therefore, when there is a difference between the appearance and color of the products in this manual and the actual product, please refer to the actual product; this manual is written according to the existing configuration and function of the product. If new configurations and functions are added to the product, this manual will also be modified without prior notice, please understand.

### **Trademark Registration**

 is a registered trademark of Matis Electric. No one may use Matis's trademarks, service marks, domain names, logos and company names without the prior written consent of Matis.

### **Credit Guarantee**

If you find any problems during use, please refer to this manual, or contact the company's customer service hotline in time, we will give you a satisfactory answer as soon as possible.

If you have any comments or suggestions on our products, please also contact us so that we can continue to improve.

## Version Information & Contact Information

Version	Release Month	Summary of Revisions
V1.0	June 2022	Create page
V1.1	September 2022	New Moulded Case Update
V1.2	October 2022	Parameter Update
V1.3	November 2022	The new version of the content is officially released after being reviewed by expert panel

If you have any comments or suggestions about the product, please feel free to contact us through the following ways.

Email: [ivan@matismart.com](mailto:ivan@matismart.com)

Website: [www.matismart.com](http://www.matismart.com)

Tel: +86 15862548861

Shanghai Office: Room 318-320, No. 83, 3rd Huanhu West Road, Pudong, Shanghai, China 201306

Suzhou Factory: Room 201, Block 29, No. 369, Lushan Road, Suzhou, Jiangsu, China, 215129